

CDMA2000

WCDMA

Bluetooth



GSM

1xEV-DO

Analog

TDMA

Version
09.00

November
2007

R&S® CMU200 Universal Radio Communication Tester

THE multiprotocol tester for current and future mobile radio networks

- ◆ Extremely high-speed testing
- ◆ Highly accurate measurements
- ◆ Modular future-proof design
- ◆ Comprehensive spectrum analyzer
- ◆ Fast switching between networks



ROHDE & SCHWARZ

Testing the 3rd generation

For more than 70 years, Rohde & Schwarz has always been at the forefront of mobile radio technology. We continue this tradition of RF test and measurement with the R&S® CMU200 Universal Radio Communication Tester. The R&S® CMU200 is a third-generation-platform design that offers true scalable multimode functionality.

The R&S® CMU200 reflects the many years of expertise Rohde & Schwarz has gained in the world of mobile radio. In recent years, the company has helped to launch overwhelmingly successful mobile radio systems.

Rohde & Schwarz is a preferred supplier to many of the leading mobile equipment manufacturers and is the market leader for mobile radio test sets.

The R&S® CMU200 is part of a complete range of mobile radio test equipment, encompassing everything from conformance test systems to system simulators, turnkey functional board test/final test systems and simple sales-counter Go/NoGo testers.

The base unit with its standard-independent module test provides many general-purpose measurement facilities for the development of all kinds of standards within its wide and continuous frequency range. If extended by the appropriate options, the R&S® CMU200 offers the hardware and software necessary to handle your 3G, 2.5G and previous-generation testing applications, including analog.

Low cost of ownership

Selecting the R&S® CMU200 is a decision for the future and results in a total cost of ownership that is sure to be among the lowest due to the following factors:

- ◆ The completely modular design of hardware and software components eliminates unnecessary investments right from the start merely because a feature might be needed at some point in the future. You only pay for what you need
- ◆ Maximum production output in a compact 4-rack-unit-high package with minimum power dissipation allows compact production space layout
- ◆ If an expansion becomes necessary because your needs grow, the modularity of the R&S® CMU200 concept will make this easy. Many expansions may be installed on site. You pay for them only when you need them
- ◆ With the intuitive R&S® CMU200 user interface, even less experienced users do not require extensive training
- ◆ A new remote interface syntax reflects the inherent modularity of this real multimode tester

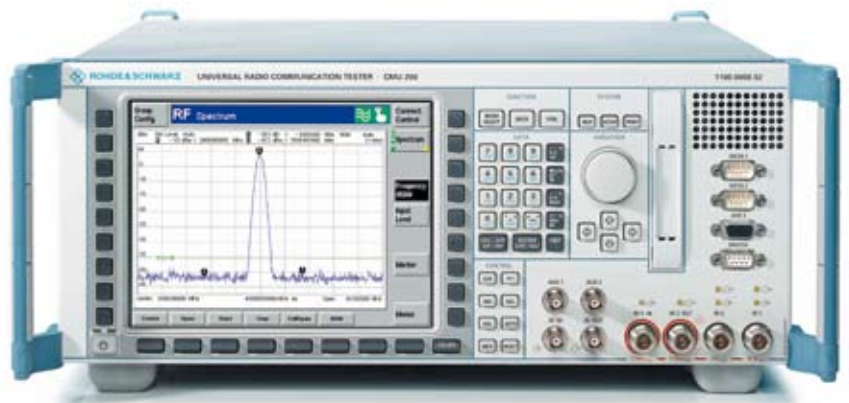

The R&S® CMU200 targets a wide range of applications but is primarily optimized for the high accuracy and speed demanded in increasingly quality-conscious manufacturing processes. The picture shows the front panel for desktop use.

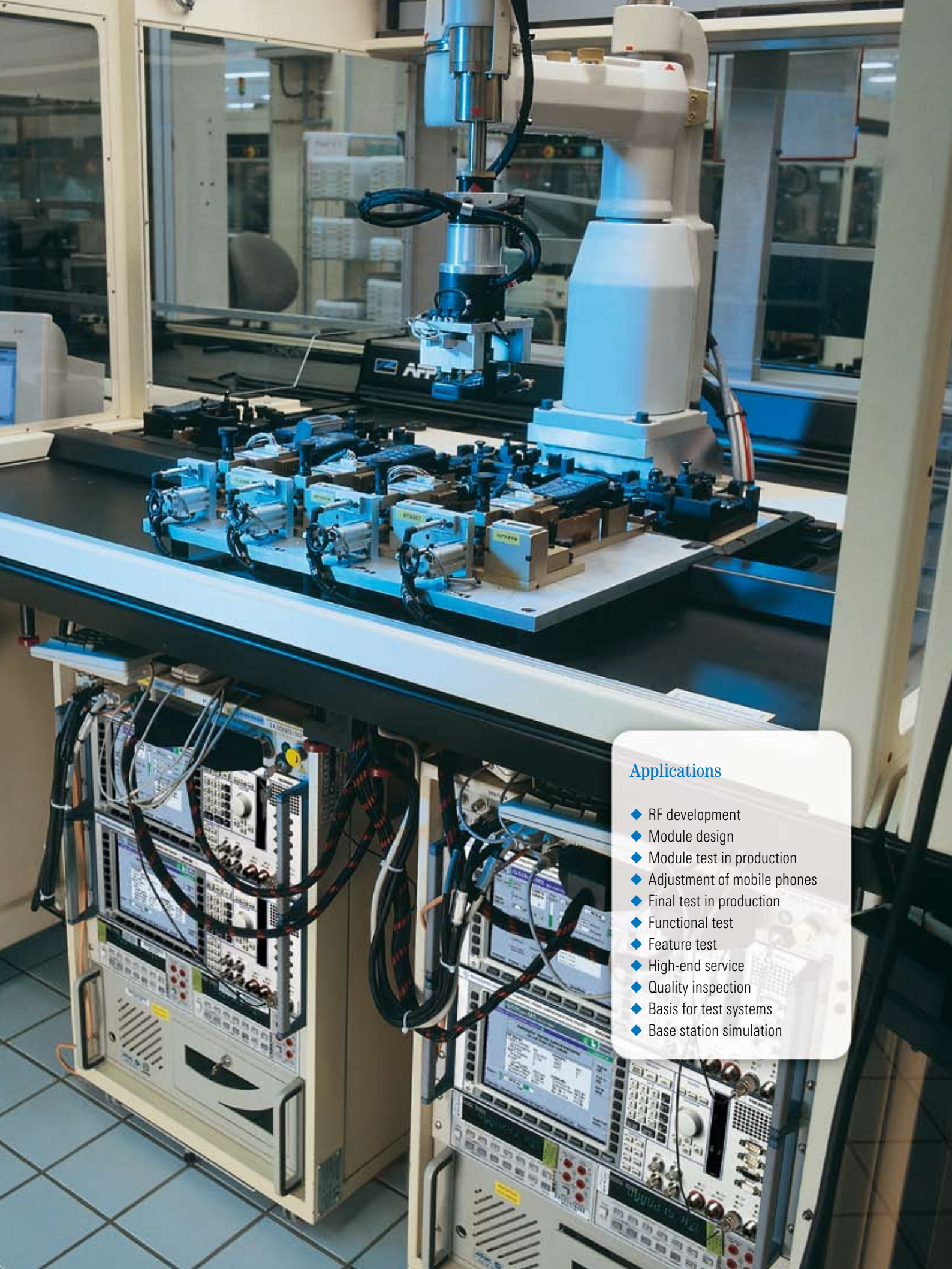

Applications

- ◆ RF development
- ◆ Module design
- ◆ Module test in production
- ◆ Adjustment of mobile phones
- ◆ Final test in production
- ◆ Functional test
- ◆ Feature test
- ◆ High-end service
- ◆ Quality inspection
- ◆ Basis for test systems
- ◆ Base station simulation

Usability

The R&S®CMU200 key strengths

The R&S®CMU200 Universal Radio Communication Tester brings premium cost effectiveness through a variety of features, with extremely fast measurement speed and very high accuracy being the two most important ones. In addition, the secondary remote addressing of the tester's modular architecture makes for intelligent and autonomous processing of complete measurement tasks and fast control program design.

Owing to the high resolution of the extremely bright high-contrast TFT display, even the finest details can be displayed

Maximum accuracy

In a production environment, the tester's high accuracy allows devices under test (DUTs) to be trimmed for maximum battery lifetime without compromising quality. In the lab, the R&S®CMU200 enables the development engineer to partly replace conventional, dedicated premium-quality instruments and save desktop space at the same time. High-precision measurement correction over the entire frequency and dynamic range as well as compensation for temperature effects in realtime are critical factors for achieving the R&S®CMU200's excellent accuracy.

Direct branching to all associated menus makes for a uniquely flat menu structure

The globally standardized Rohde&Schwarz calibration system can check the R&S®CMU200's accuracy at a service center close to you or, in some cases, on your premises. A worldwide network of these standardized automatic calibration systems has been implemented in our service centers. Highly accurate and repeatable calibration can be performed wherever you are. Your local Rohde&Schwarz representative offers customized service contracts. For large-scale users of the R&S®CMU200, a compact level verification system is available in addition.

Top speed

The high processing speed is due to extensive use of ProbeDSP™ technology, parallel measurements and innovative remote command processing.

- ◆ ProbeDSP™ technology
The modular architecture relies on decentralized ProbeDSP™ processing coordinated by a powerful central processor. Like an oscilloscope probe, DSPs dedicated to a specific local data acquisition and evaluation workload help to keep subsystem performance at a maximum even if additional modules are fitted to the R&S®CMU200 mainframe
- ◆ Parallel measurements
Several RX and TX measurements can be performed in parallel. This is achieved by the fast response of the R&S®CMU200's modular hardware as well as the high overall processing power of the instrument and the avoidance of bottlenecks by dedicated operation of the

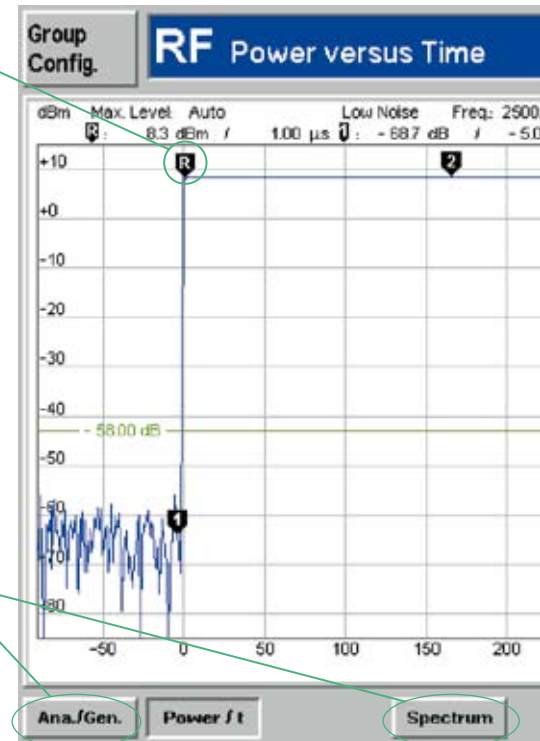

ProbeDSP™ technology. Examples of parallel operation are measurements of BER and simultaneous phase/frequency error, error vector magnitude (EVM), magnitude error and audio, or the various spectrum measurements

- ◆ Innovative remote processing
The novel secondary addressing mode can address similar functions of each of the R&S®CMU200 subsystems (i.e. different mobile radio standards) in an almost identical way. Using this type of addressing, new remote test sequences can be programmed by a simple cut-and-paste operation followed by the editing of specific commands to adapt the control program to the new application. Secondary addressing is fully SCPI-compliant, which means that a subsystem address, for example WCDMA, can be replaced by a string denoting a different subsystem, i.e. another mobile radio standard

As the R&S®CMU200 offers many of its measurements in signaling and non-signaling mode, this simple visual indication of the signaling state is provided as part of the status line

This symbol shows the instrument status, i.e. remote or manual operation

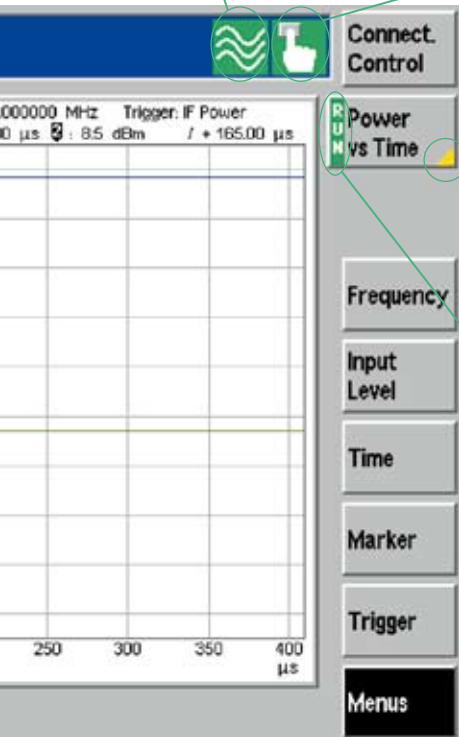

For increased speed, measurements not required can be switched off to free resources for the measurements you want to focus on

Measurements are configured by twice pressing the softkey marked with the yellow triangle

Exceptional reliability

The R&S®CMU200 employs ultra-effective heat management between housing and individual components as well as between heat sinks and air flow. Together with the independent cooling cycles for different modules, this adds up to an optimized cooling system.

The base unit

The base unit without any options installed can be used for testing general parameters of 1st, 2nd or 3rd generation mobile phones. The R&S®CMU200 base unit is the ideal solution for tasks at the module level, i.e. at the early production stages of all cellular standards.

Integral parts of the R&S®CMU200 base unit are the RF generator and RF analyzer, which are complemented by a versatile, network-independent time domain menu and a comprehensive spectrum analyzer. The illustration above shows a power versus time measurement as an example.

By combining graphical and numeric overview menus, the user can select the optimal view when the R&S®CMU200 is in manual mode.

The menu structure of the R&S®CMU200 is very flat and uses context-sensitive selection, entry and configuration pop-up menus.

Advanced operational ergonomics have been incorporated into a highly compact and lightweight, 4-rack-unit-high package.

Key advantages of the R&S®CMU200

Speed

- ◆ Unrivalled speed of single measurements

Accuracy

- ◆ Incomparable accuracy
- ◆ Excellent result repeatability

Modularity

- ◆ Modular hardware and software concept provides easy expansion to further functionality

Reliability

- ◆ Extremely low power consumption and effective heat conduction result in unparalleled reliability

Future-proof

- ◆ Easy migration to emerging standards

Optimized solutions for your production test requirements

Rohde & Schwarz supports R&S®CMU200-based production test solutions through a comprehensive network of application engineering sites. The backbone of this network consists of the four system integration centers located in Asia, North America and Europe.

System integration services

Regional center project teams offer local system integration, service and support. A team of experts is ready to provide turnkey solutions, including test case programming. Custom-tailored project solutions and site process optimization are major aspects of our services.

Time to market

The key to commercial success is the time required to get a new product to market in large numbers. The crucial point is the fast transition from product development to mass production. The Cellular Phone Production Test Platform R&S®TS7180 featuring the R&S®CMU200 meets this challenge.

R&S®TS7180 description in brief

The R&S®TS7180 test platform can test two mobile phones simultaneously. It essentially consists of two Radio Communication Testers R&S®CMU200, two Dual-Channel Analyzers/Power Supplies R&S®NGM02, two Shielded RF Test Fixtures R&S®TS7110 for holding the DUT, and an industrial PC. The modular RF Test Fixture R&S®TS7110 can be expanded from a bed-of-nails PCB test fixture up to a fully configured test fixture for final testing, including an antenna for RF tests, a loudspeaker and microphone for acoustic tests, a camera for LC display

tests, a test pattern for the camera of the DUT, and pneumatic fingers for keypad tests.

The Shielded RF Test Fixture R&S®TS7110 for mobile phones can be adjusted by means of swap kits to accommodate several types of DUTs. It can be used for the following tests:

- ◆ RF (antenna)
- ◆ Audio
- ◆ LC display
- ◆ DUT camera and keypad and other DUT interfaces



The Shielded RF Test Fixture R&S®TS7110.

The R&S®TS7180 supports common mobile radio standards such as GSM, GPRS, CDMA2000® and WCDMA by means of ready-to-run test sequences supplied with the platform. The test sequences can be extended and modified by means of a flexible sequence editor.

The software can thus simultaneously use the resources of the parallel equipment to maximize speed in highly automated production. We can offer optimally configured test systems customized to your production environment.

Test executive and generic test software library features

The parallel hardware is fully supported by TestStand, the industry-wide test executive from National Instruments. A user-friendly connection to the available device drivers has been created to provide faster use of the test executive. This connection is established by the generic test software library (GTSL). At the same time, the toolkit concept provides ready-to-run test cases, which can be customized by the user as required.

Sequence editor

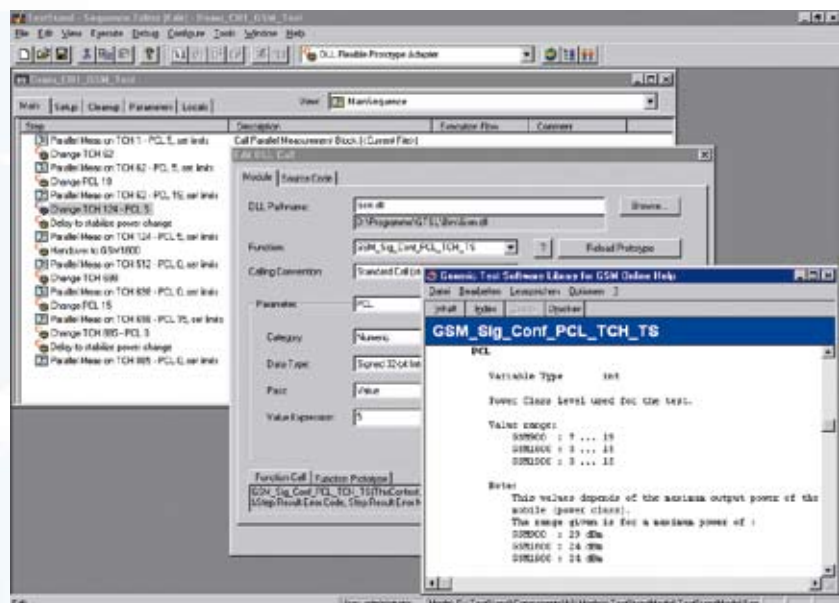

R&S® TS 7180/7110 features in brief

- ◆ High throughput by parallel testing of mobile phones
- ◆ One system for functional board test, phone calibration and final test
- ◆ One system for all major mobile phone standards
- ◆ Easy expansion to 3rd generation technologies
- ◆ Ready-to-run Rohde & Schwarz GTSL test library for immediate use or customization
- ◆ Modular and versatile hardware/software platform
- ◆ Reduced costs due to generic concept
- ◆ Swap kit

For detailed information, see separate data sheets:

R&S® TS 7110 (PD 0757.7723)

R&S® TS 7180 (PD 0757.7469)

R&S® TS7180:
example of a
two-channel
system with one
R&S® TS 7110
fixture.



Software concept in brief

- ◆ Software platform based on LabWindows/CVI and TestStand from National Instruments
- ◆ GTSL includes ready-to-run test cases for the standards supported by the R&S® CMU200
- ◆ Functional test sequences for RF test, calibration, signaling test, audio and acoustic test of mobile phones are supported
- ◆ Transparent and open library can be expanded by the user
- ◆ Operator interface (GTOP) and test cases can be easily customized
- ◆ Parallel test of multiple mobile phones is fully supported
- ◆ GTSL supports multithreading and instrument sharing if needed
- ◆ Test development time is reduced by as much as 80 %

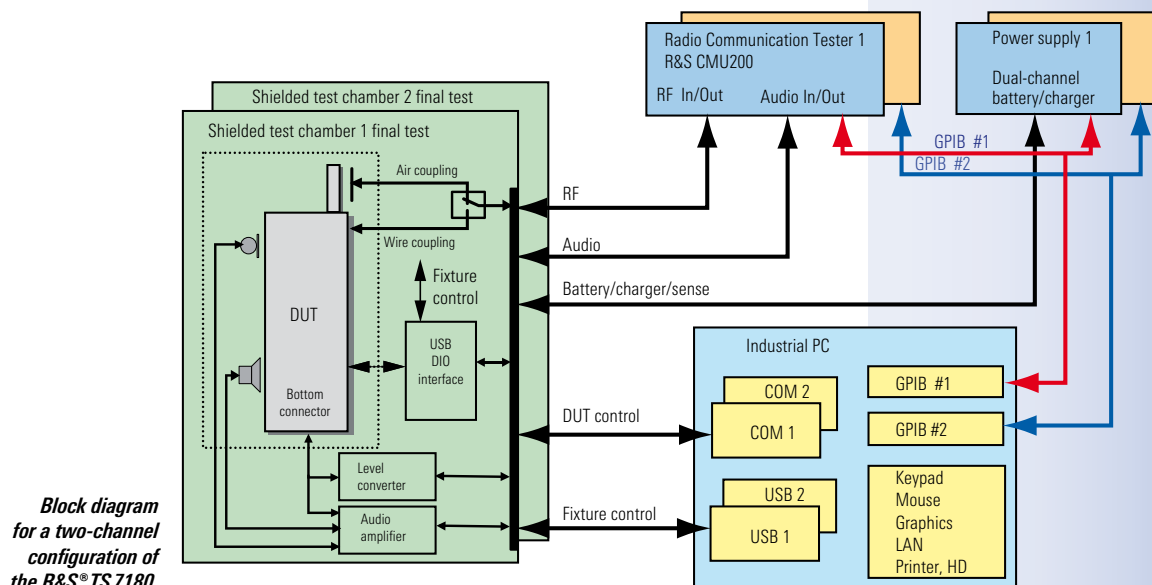

Block diagram
for a two-channel
configuration of
the R&S® TS 7180.

Ready for today's networks ...

GSM today

Since its introduction in the early nineties, the GSM system has won acceptance and undergone an evolution that no one could have foreseen.

Currently, the following GSM systems are deployed in support of numerous applications worldwide:

- ◆ GSM400
- ◆ GSM850
- ◆ GSM900 including
 - P-GSM (primary GSM)
 - E-GSM (extended GSM)
 - R-GSM (railway GSM)
- ◆ GSM1800 (DCS)
- ◆ GSM1900 (PCS)

Whether the application is in production, service or development, the flexible concept of the R&S®CMU200 can handle practically all requirements: from basic RF signal generation, frequency, power and spectrum analyzer measurements for the alignment of modules in production or development, to full GSM-specific signaling in any of the above-mentioned bands, as well as module tests on frequencies anywhere in the range from 10 MHz to 2.7 GHz.

Signaling mode

The R&S®CMU200 simulates a GSM base station RF interface, providing the signaling flexibility necessary to test the performance of a mobile phone under the influence of different signaling parameters. These parameters are normally set by the network operator but can be reproduced by the R&S®CMU200 for test purposes. The instrument supports the latest fast location update and direct paging features.

Reduced signaling synchronized mode

The R&S®CMU200 provides the same functionality as in the signaling mode but discards any signaling response from the mobile phone connected. This mode of operation enables testing of modules that only have layer 1 capabilities as well as very fast RF testing in production environments. It can also skip the location update procedure in order to save time.

Non-signaling mode

This mode is used to generate a signal with GSM-specific midambles and modulation in the entire frequency range from 10 MHz to 2.7 GHz. The analyzer offers the same flexibility for GSM-specific transmitter measurements such as

- ◆ Modulation analysis
- ◆ Average and peak burst power
- ◆ Power versus time, power versus slot, power versus frame
- ◆ Spectrum due to switching/modulation

GSM development

As a tool for GSM development engineers, the R&S®CMU200 is an unsurpassed solution. The RF interface provides four input and output connectors offering a wide range of signal levels for the generation and analysis of RF signals. Input-only connectors, as well as combined input/output connectors, can analyze mobile phones or modules with a sensitivity down to -80 dBm and up to $+47$ dBm for the power meter. RF signals can be generated with levels from -130 dBm up to $+13$ dBm, depending on the selected connector.

All measurement tolerances are set by default in line with the 3GPP TS 51.010 and 3GPP TS 45.005 recommendations but may be altered to suit individual needs.

Production of mobile phones

Production is a process that calls for cost effectiveness. The R&S®CMU200 concept is optimized for IEC/IEEE bus speed, measurement accuracy and reproducibility as well as cost of ownership. Owing to multitasking capability and parallel measurements, previously unobtainable test times can be achieved.

The flexible R&S®CMU200 hardware concept allows the latest DSP technologies to be used in measurements, e.g. to speed up transmitter measurements (spectrum due to switching/modulation) to the extent that measurements virtually in realtime are possible.

The ability to process BER data and perform transmitter measurements at the same time allows phase/frequency error, power versus time and average power (PCL accuracy) to be measured during the time-consuming receiver test.

The accuracy and reproducibility ensure correct and stable measurement results and thus contribute to the quality and reliability of the end product.

GSM speech evolution – AMR

Maintaining good voice quality even under extremely poor transmission conditions is now possible with the innovative adaptive multirate (AMR) voice coding algorithm, which opens up new possibilities for GSM. The new algorithm allows voice quality to be gradually reduced in favor of improved error correction by

The GSM-specific non-signaling test provides generation and analysis of RF signals (GMSK or 8PSK modulated) for testing RX/TX modules or mobile phones in service mode.

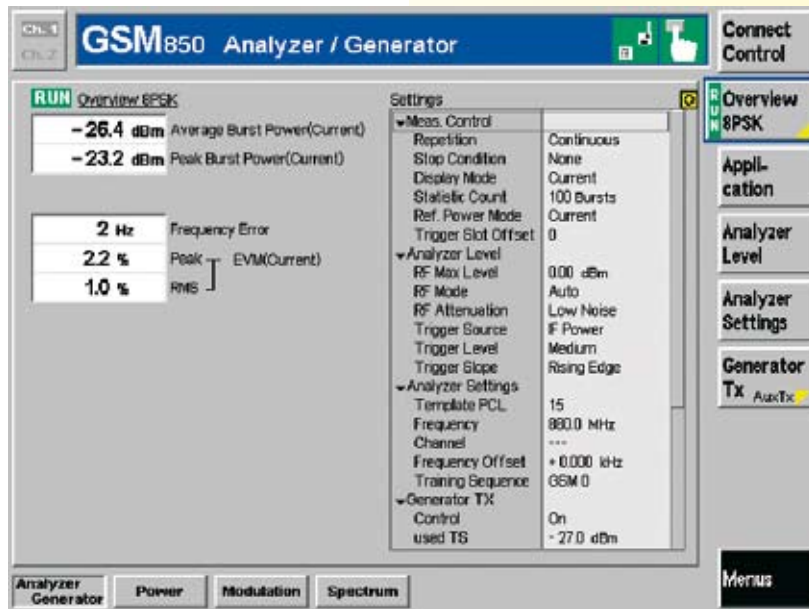

For an AMR full-rate or AMR half-rate link, a rate set of up to four combinations of voice and channel codings (codecs) can be selected from the eight full-rate and the six half-rate codecs. During a call, it is possible to switch between the rates of the rate set.

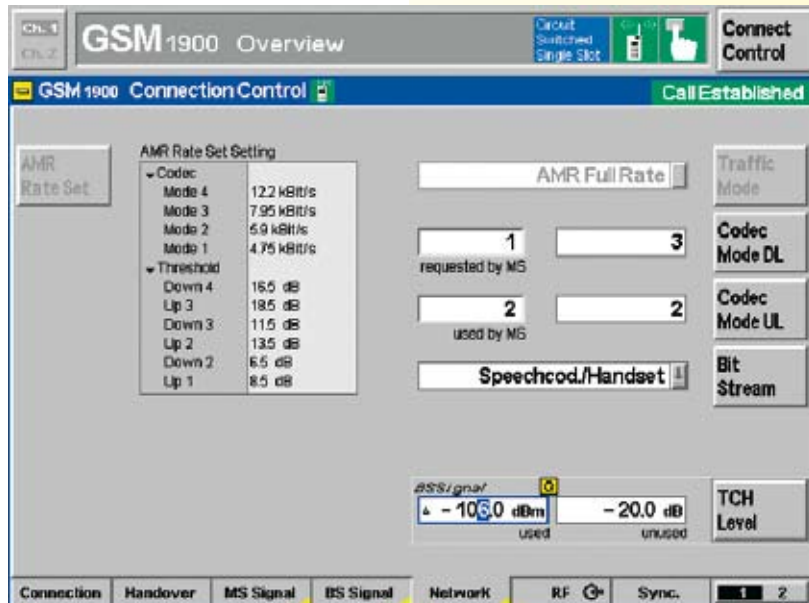

The overview menu provides fast comprehensive information on the mobile phone's RF performance; the hotkeys at the bottom of the screen provide immediate access to specific and detailed GSM measurements.

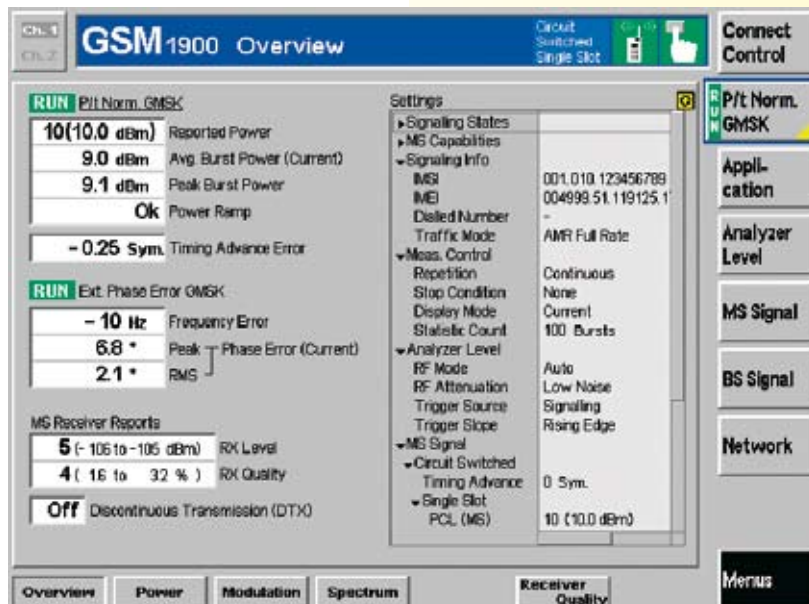

dynamically adapting the data rate. Interruptions of voice transmission can thus be avoided by allowing a barely perceptible reduction in audio quality. The R&S®CMU200 provides all eight combinations of voice and channel coding (codecs) for full-rate and six combinations for half-rate transmission. For call setup, a set of four rates (codecs) is selected from the eight full-rate and the six half-rate codecs. Then additional test parameters (thresholds) are selected for the mobile phone. Dynamic switchover between the selected rates is effected by AMR inband signaling. In the uplink, the mobile phone informs the base station about the quality of the established link and proposes the optimal rate for the selected rate set to the base station.

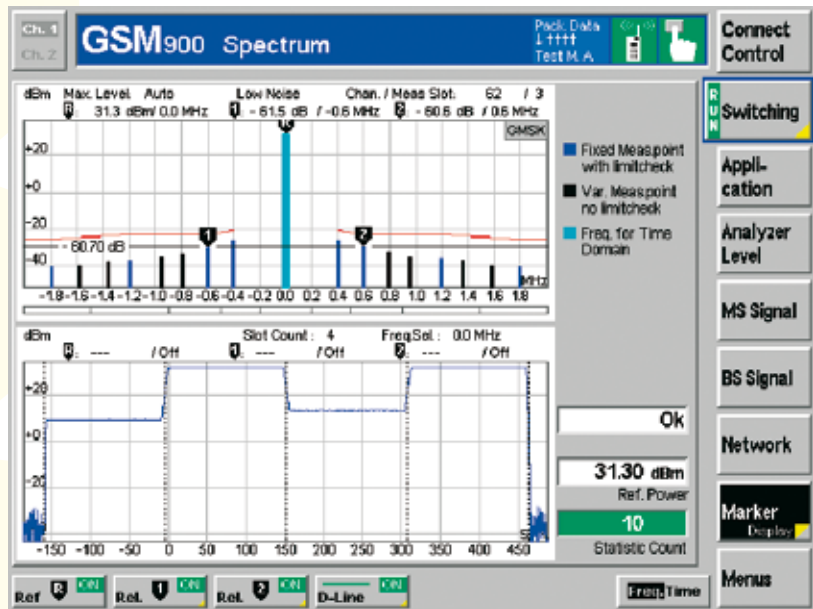

The newly designed spectrum application allows the simultaneous measurement of spectra due to switching and modulation in realtime. Moreover, the user can select a frequency offset (spectral line) by means of a marker and display it in the time domain. Transient characteristics in spectrum-due-to-switching measurements can thus be shown as a function of time.

GSM data evolution – 2.5G

The amount of data traffic in GSM networks is growing rapidly. Multislot applications such as HSCSD, GPRS and the innovative 8PSK modulation scheme EDGE are needed to support the increase in data traffic. The R&S®CMU200 platform is not only able to handle today's standards and systems but is also designed for the needs of tomorrow.

Multislot

In the future, mobile phones will be able to use several timeslots simultaneously for data transmission and reception to further increase the data rate. The simultaneous transmission and reception of several timeslots (multislot) is the main technological challenge for circuit-switched and packet-switched applications. The following expansions of the GSM single-slot measurements enable maximum flexibility in development, and, with reduced measurement times, maximum throughput in production.

- ◆ Individual levels for all timeslots used in the downlink (DL). The R&S®CMU generates up to eight timeslots per frame in the downlink; each timeslot can be assigned a separate level. The excellent level stability of the R&S®CMU200 generator is not impaired by multislot transmission using different levels, and allows highly accurate receiver sensitivity measurements (BER/BLER)
- ◆ Transmitter and receiver measurements are possible on every timeslot used. The new multislot concept allows independent measurements on any timeslot (TS 0 to 7) and thus covers the current and future multislot combinations without restrictions
- ◆ The R&S®CMU200 combines high flexibility with great operating convenience. Based on the multislot capability information from the mobile phone, the R&S®CMU200 selects the maximum possible number of timeslots for a specific application and, when changing between transmitter and receiver tests, automatically adapts the timeslot allocation
- ◆ Power-versus-time measurement (graphical display) for up to four timeslots in the uplink (UL). The templates of this application are evaluated independently for each timeslot – in line with standards and recommendations. Both GMSK- and 8PSK-modulated signals are recognized, and the templates of the relevant timeslot, depending on the modulation scheme used, are set in realtime

Multislot measurements are required for HSCSD technologies as well as for GPRS and EGPRS.

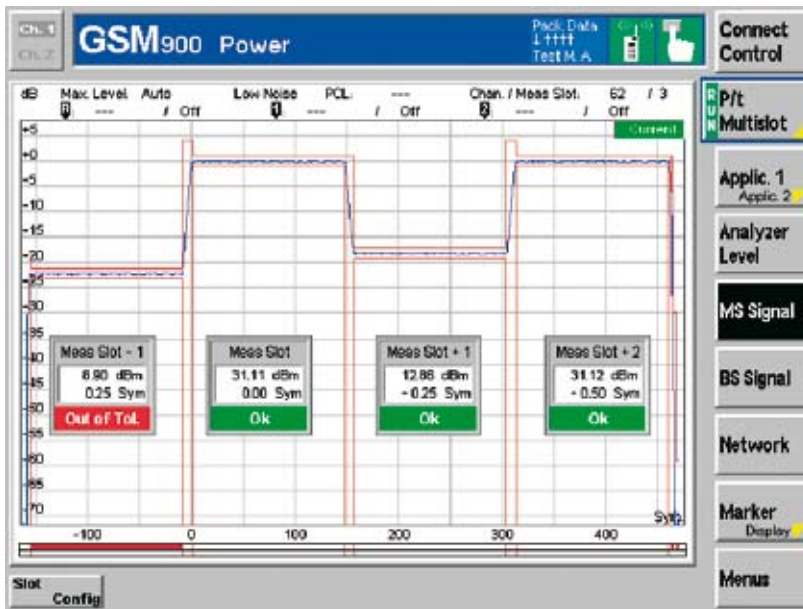

The power-versus-time multislot application can graphically display up to 4 adjacent timeslots, automatically detect GMSK- and 8PSK-modulated signals and activate the associated templates in real-time. A new zoom function allows full-screen display of up to four slots. Moreover, the user can zoom in anywhere along the time or power axis.

8PSK modulation – EDGE

In addition to multislot, a further step toward increasing the mobile radio data rate is 8PSK. By using the available GSM frame structure, the gross data rate is three times that obtained with GMSK. Error vector magnitude and magnitude error have been added to the range of modulation measurements. New templates for power-versus-time measurements ensure compliance with the specifications, as do the modified tolerance for spectrum measurements. As with all measurements provided by the R&S®CMU200, special attention has been given to achieving maximum measurement accuracy and speed for EDGE.

GPRS/EGPRS

With newer, future-oriented methods of packet data transmission, the radio resources of existing GSM mobile radio networks can be utilized efficiently for data services. As with circuit-switched services, GPRS will also use a combination of several timeslots (multislots) and higher-level modulation in the form of 8PSK (EGPRS) to increase the data rate. The introduction of packet-oriented transmission and the associated temporary assignment of radio resources require new test concepts. The R&S®CMU200 provides the following test modes:

3GPP test mode A (GPRS/EGPRS)

In this mode, the mobile phone continuously transmits the associated UL timeslots. The R&S®CMU200 can carry out all TX multislot measurements available, such as the power ramp measurement of up to four adjacent timeslots simultaneously, or modulation and spectrum measurements.

Selecting the coding scheme determines whether the mobile phone is to transmit GMSK- or 8PSK-modulated data. With GPRS/EGPRS, transmission resources are usually allocated temporarily. The uplink state flag (USF) transmitted in the downlink informs the mobile phone that uplink resources have been allocated for the next block and that these resources have to be used. Correct decoding of the highly protected USF sequence is an essential prerequisite for the “dynamic allocation” and “extended dynamic allocation” modes to work properly, and is verified by the R&S®CMU200 by means of the USF BLER test (test modes A and B). Various routines, e.g. USF BLER and false USF detection, are available.

3GPP test mode B (GPRS/EGPRS)

This mode creates a loopback in the mobile phone so that the mobile phone retransmits data blocks received from the R&S®CMU200. To achieve maximum measurement speed, the test mode does not employ the backward error correction function used in packet data transmission, which enables the acknowledgement-based (acknowledged/not acknowledged) retransmission of erroneous data blocks. The transmitter and the receiver are active at the same time. The mobile phone returns the received data blocks to the R&S®CMU200 unchanged, comparable to the loopback mode in circuit-switched operation. The data is looped back after channel coding, which means that the mobile phone’s coder and decoder functions are tested as well.

In addition to the measurements available in the 3GPP test mode A, test mode B enables very fast receiver test, bit error ratio and Rohde & Schwarz-proprietary block error ratio measurements in parallel to transmitter tests (BER/DBLER)

3GPP EGPRS symmetrical and non-symmetrical loopback mode (EGPRS only)

Unlike in test mode B, the data blocks are looped back before they undergo channel coding, i.e. the coders are bypassed in favor of increased measurement speed. In the symmetrical (E)GPRS loopback mode, 8PSK-modulated data blocks are received in the downlink and returned unchanged in the uplink. In the non-symmetrical mode, 8PSK data blocks are received in the downlink and returned in the uplink as GMSK-modulated data spread over the next three data blocks. Similar to test mode B, the (E)GPRS loopback mode allows simultaneous transmitter and receiver tests to be performed at an even higher data throughput.

3GPP BLER measurements – acknowledge mode (GPRS/(E)GPRS)

The BLER measurement mode employs GPRS/(E)GPRS backward error correction. The R&S®CMU200 sends data blocks in allocated timeslots in the downlink. The mobile phone checks the data blocks for errors (CRC check) and, instead of returning the data blocks, returns only the block acknowledgements in the uplink. The mobile phone transmitter is thus only temporarily active for sending uplink acknowledgements, which means that transmitter measurements are possible only to a limited extent in the BLER mode.

For R&D requirements, the BLER menu opens up a wide range of options to determine receiver characteristics even beyond the scope of the 3GPP test scenarios. The R&S®CMU200 furnishes an average result over all timeslots used, as well as the BLER and the actual data throughput for each timeslot. The downlink transmitter level can be varied separately for each timeslot and is displayed as an important test parameter together with the data throughput and the resulting BLER. The (E)GPRS BLER measurement is based on a new retransmission algorithm referred to as “incremental redundancy”.

Incremental redundancy means that errored blocks are retransmitted using a different puncturing scheme. The R&S®CMU200 can cycle through the puncturing schemes as specified by the 3GPP standard, or start with a specific puncturing scheme, or use the same puncturing scheme throughout (incremental redundancy OFF).

Fast production test mode for test modes A, B and (E)GPRS loop (GPRS/(E)GPRS)

Extremely fast adjustment and testing of RF parameters during mobile phone production is ensured by deactivating the GPRS/(E)GPRS protocol stack. Without using all functions on the higher protocol layer (RLC/MAC layer), the R&S®CMU200 synchronizes the mobile phone (camping), and the data channel (PDCH) is then set up directly without executing the time-consuming routines of location update and GPRS/(E)GPRS attach. Any signaling for reconfiguring the test setup is likewise omitted. The fast production test mode developed by Rohde & Schwarz provides test conditions comparable to those defined for the 3GPP test modes. The R&S®CMU200 performs all transmitter and receiver measurements described by 3GPP, but at a considerably higher speed.



...making the right connections.

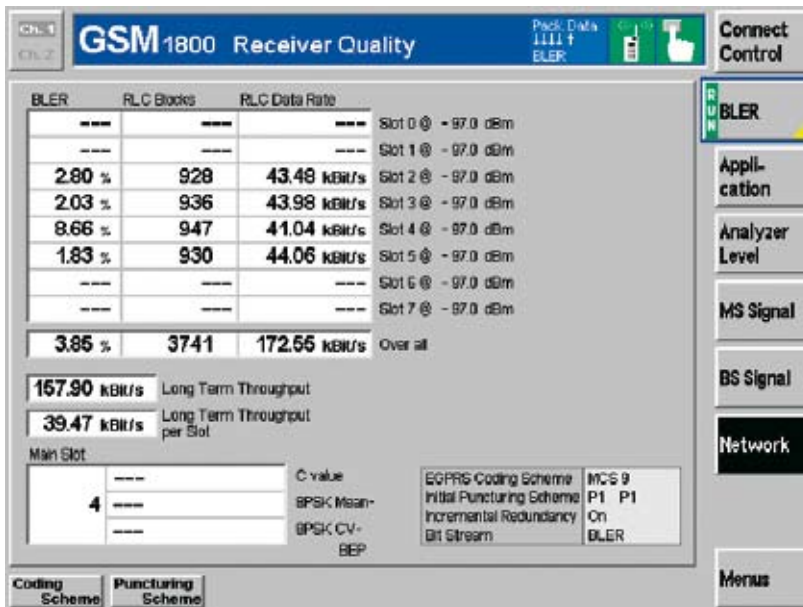

For GPRS/EGPRS, BLER measurements can be performed simultaneously on up to four downlink timeslots. The actual data throughput, the BLER and the resulting data rate (RLC/MAC layer) are displayed separately for each timeslot and as an average for all timeslots used. Furthermore an incremental redundancy performance test is performed, and the channel quality is indicated.

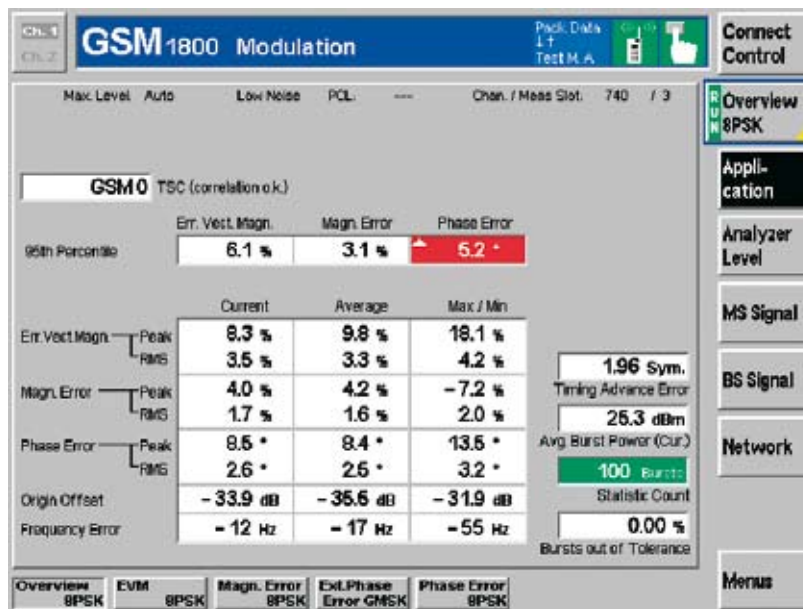

In the 8PSK mode, the modulation analysis is subdivided. The error vector magnitude (EMV), the magnitude error and the phase error can be displayed both numerically as shown above, or graphically.

GSM highlights of the R&S®CMU200

Benchmark-breaking IEC/IEEE bus speed due to

- ◆ Optimized processing power and fast modulation spectrum measurement using latest DSP generations
- ◆ Statistical BER test based on confidence evaluation

High flexibility for R&D

- ◆ Assignment on up to 8 UL and DL slots (TS 0 to 7)
- ◆ TX/RX on any transmit slot
- ◆ Individual level generation on any DL slot used
- ◆ 3GPP packet data test mode supporting modes A, B and (E)GPRS loop
- ◆ GPRS/(E)GPRS TBF reconfiguration during established link
- ◆ GPRS/(E)GPRS intra-band handover

GMSK/8PSK measurements

- ◆ Phase/frequency error, EVM, magnitude error, origin offset, I/Q imbalance GMSK for I/Q modulator tuning
- ◆ Power versus time
 - On up to 4 UL slots
 - Normal/access
 - Peak power/average, power versus frame, power versus slot
- ◆ High-speed ACP measurement (switching and modulation measurement in parallel) with additional time domain view
- ◆ Timing error
- ◆ BER/DBLER, RBER/FER, FastBER BLER@4DL (GPRS/EGPRS)
- ◆ Incremental redundancy support ((E)GPRS)
- ◆ Power versus PCL (on 3 or 7 channels)

WCDMA in the R&S®CMU200

The need for higher data rates is the consequence of an information-oriented society in the new millennium. The enhancement of mobile devices takes this need into account. Third-generation wireless communications pose new challenges. Driven by ideas of the first and second generation (SIM, global roaming, CDMA technology, data services), WCDMA takes all fundamentals to unprecedented levels and adds new application fields as well as application-tailored data security. Derived from Asian, American, and European ideas, 3G networks are the mobile solution for future needs as well as the current mainstream.

WCDMA FDD functionality

The tests provided by the R&S®CMU200 are based on 3GPP/FDD Release 99 and optional R5/R6¹⁾ 2) WCDMA radio link standards. Regular adaptations to new releases and baselines are made as the standard evolves; thus the R&S®CMU200 today supports Release 5 as well as Release 6. Most of the measurements offered comply with the 3GPP specification TS 34.121, chapter 5 (transmitter characteristics), chapter 6 (receiver characteristics), chapter 7 (performance tests), and chapter 9 (performance requirements for HSDPA)¹⁾ and chapter 10 (Performance Requirements for HSUPA)²⁾.

The R&S®CMU200 can be equipped with an FDD transmitter tester, an additional FDD generator, and FDD signaling hardware. Depending on the application, only the first or the first two might be needed, allowing T&M budgets to be optimized. The three units allow the R&S®CMU200 to be configured for non-signaling TX, TX/RX or signaling TX/

RX measurements and functional testing on the UE (user equipment) in line with the 3GPP specification. Due to the highly user-friendly menu concept, the R&S®CMU200 provides quick access to all required measurements and optimizes the handling and thus the efficiency of complex measurement tasks with appropriate status messages and built-in statistical functions. Different WCDMA/FDD handover capabilities such as inter-frequency and inter-band handover are available in the R&S®CMU200 WCDMA solution. Moreover, handover to other cellular networks such as GSM, i.e. inter-RAT handovers – blind or in compressed mode – are implemented.

Non-signaling mode

The non-signaling mode is for generating and analyzing WCDMA (3GPP/FDD) signals in the full frequency range of the R&S®CMU200 base unit. The R&S®CMU200 provides WCDMA-specific TX measurements on signals with up to six DPDCHs such as:

- ◆ ACLR (adjacent channel leakage power ratio): two measurement modes, filter (bargraph) and FFT (cont. spectrum) method; absolute or relative readout
- ◆ OBW (occupied bandwidth)
- ◆ SEM (spectrum emission mask)
- ◆ CDP (code domain power): CDP vs all codes, CDP vs DCH channels, RHO vs all codes, RHO vs DCH channels; all measurements in relative or absolute readout, CDP versus time
- ◆ Modulation (for 3GPP or general QPSK): EVM (error vector magnitude), magnitude error, phase error, frequency error, I/Q offset, I/Q imbalance, peak code domain error, RHO (waveform quality), transmit time error, I/Q constellation/vector/eye diagram

- ◆ Power: MAX, MIN, OFF (UE test mode)
- ◆ Power versus slot, inner loop power
- ◆ Phase discontinuity

The non-signaling mode allows tests of all essential RF parameters of the connected UE, where autoranging for the received UE signal is also applied. The measurements are performed in unsynchronized mode. No call is set up to evaluate UE performance using this mode. No 3GPP FDD generator option is needed. The capability to use different 3G dedicated triggers such as signaling trigger, IF, TPC, frame or slot trigger, HSDPCCH etc, together with the flexible trigger settings such as delay and delay offset make this an interesting tool for R&D applications where a protocol stack is not available.

Reduced signaling synchronized mode

This mode requires the 3GPP FDD generator option to be installed on top of the transmitter tester. This generator for the R&S®CMU200 provides all necessary forward link channels and 3GPP-conforming AWGN and orthogonal noise signals. 16 channels with OCNS can be added and their power levels changed.

The generated channels and available functions include the following:

- ◆ P-CPICH/P-SCH/S-SCH/P-CCPCH/S-CPICH/PICH/DPCCCH/DPDCH
- ◆ Flexible adjustments of physical parameters such as power, code, etc for physical channels, including the generation of data (pseudo noise sequences, and fixed data patterns)
- ◆ TPC profiles (three predefined, one user-defined setting, seven user-selectable, five definable TPC setups)

¹⁾ More about the HSDPA capabilities in the following section.

²⁾ More about the HSUPA capabilities in the following section.

WCDMA in the R&S®CMU200

- ◆ OCNS (16 orthogonal channels)
OCNS/Rel. 99 and OCNS/Rel. 5
- ◆ AWGN

The R&S®CMU200 generator can also provide non-channel-coded data on the physical layer and allow slot formats from 0 through 16 to be selected. Synchronization of the UE (but still no call setup) is mandatory for RX evaluation, synchronized TX measurements, and additional TX measurements such as inner-loop power control with TPC commands:

- ◆ TPC stepping measurement (UE receives TPC commands from the R&S®CMU200 generator)
- ◆ Receiver quality: BER, BLER, and DBLER (two modes, UE-assisted evaluation, or RF loopback (realtime receiver option needed))
- ◆ Phase discontinuity measurement

Using the R&S®ABFS baseband fading simulator and the R&S®CMU200 with optional IQ/IF interface, conditions of fading may be simulated and the results evaluated with the R&S®CMU200. In contrast to RF fading, a baseband fading scenario makes it possible to maintain the extremely high downlink accuracy provided by the R&S®CMU200 3GPP FDD generator. In addition, baseband-faded testing usually comes at a much lower cost than an RF fading solution. All fading tests are possible in synchronized or signaling mode. The optional IQ/IF interface can also be used for baseband testing when no RF section of the UE is available in R&D.

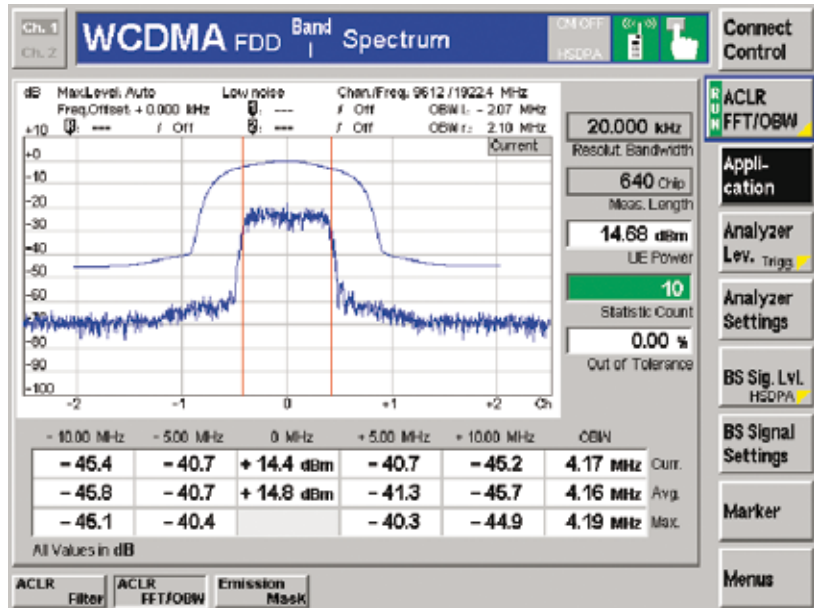

The ACLR menu shows all adjacent-channel-related information in graphical as well as in scalar numeric form. Since the ACLR FFT and OBW measurement methods are closely related, results for occupied bandwidth are displayed simultaneously. The scalar display excluding the center channel (0 MHz) may be switched to absolute readout as well.

FDD signaling mode

Signaling tests are tests in an environment closer to a true live network. 3GPP currently specifies eleven different operating bands for FDD (bands 1 through 11). All eleven bands are optionally supported by the R&S®CMU200.

The measurements offered are largely the same as performed in synchronized mode. In signaling mode, the R&S®CMU200 simulates one WCDMA base-station RF interface including the signaling protocol so that an FDD UE can be tested with regard to various signaling parameters. All necessary network and Node B (base station) parameters such as control and data channel configurations can be set. In addition to the non-signaling tests, the R&S®CMU200 provides features such as:

- ◆ Dynamic setting of signaling parameters
- ◆ RRC connection setup

- ◆ Readout of UE capabilities
- ◆ Authentication and security (integrity)
- ◆ Call setup (MOC, MTC)
- ◆ Call release (NIR, MIR)
- ◆ Measurements from non-signaling section
- ◆ Open-loop power control (on/off time mask for RACH preambles)
- ◆ Modulation quality measurements during the random access procedure (PRACH preambles)
- ◆ Phase discontinuity in line with 3GPP TS 31.121 chapter 5.3.13
- ◆ Inner-loop power control (traffic power commands, TPC patterns A to H)
- ◆ Test mode/test loop activation command (test loop mode 1, transparent, and test loop mode 2 with and without uplink CRC)
- ◆ BTFD (blind transport format detection) with false transmit format detection ratio (FDR) and transport format indicator (UL TFCI)

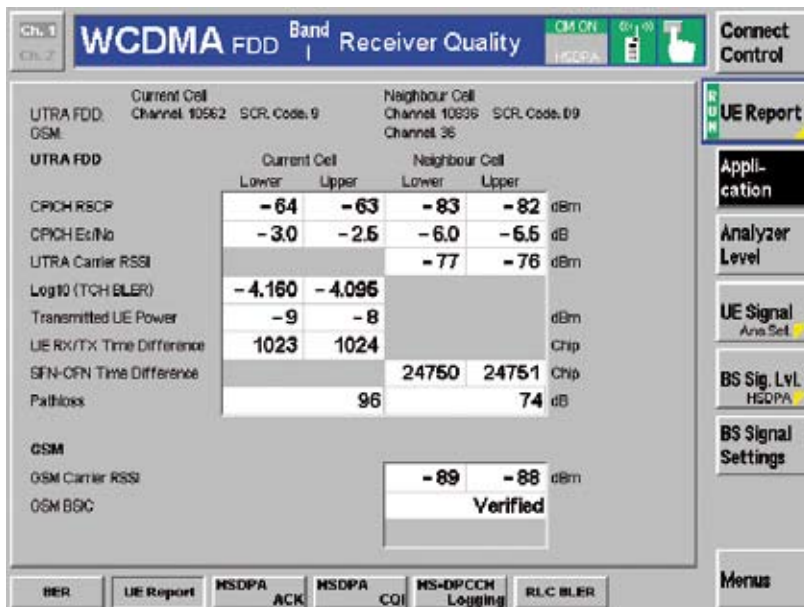

The UE reports for the current and neighbor FDD cell (can be obtained from an existing FDD cell on the air, for example) and from a neighbor GSM cell can be requested by activating the compressed mode patterns. Four predefined compressed mode patterns can be combined. The R&S®CMU200 also provides full flexibility with user-defined patterns as well as all 3GPP defined compressed mode patterns.

- ◆ Receiver quality: BER, BLER, and DBLER (RF loopback)
- ◆ Readout of UE measurement reports on current and neighbor cell (UTRA/GSM) (with activated compressed mode (CM))
- ◆ Several possibilities for handovers: from WCDMA to GSM (blind and compressed mode), and back from GSM to WCDMA (blind handover), including neighbor cell measurement
- ◆ WB-AMR (optional) at 23.85 kbit/s, 23.05 kbit/s, 19.85 kbit/s, 18.25 kbit/s, 15.85 kbit/s, 14.25 kbit/s, 12.65 kbit/s, 8.85 kbit/s, 6.60 kbit/s (codec set A to I, M) with selectable audio loopback
- ◆ RMC at 12.2 kbit/s, 64 kbit/s, 144 kbit/s, 384 kbit/s
- ◆ Asymmetric RMC at
 - UL/144 kbit/s DL/64 kbit/s
 - UL/384 kbit/s DL/64 kbit/s
 - UL/384 kbit/s DL/144 kbit/s
- ◆ BTFD (blind transport format detection)
- ◆ 12.2 kbit/s RMC in combination with HSDPA and HSUPA (optional)
- ◆ Video call in loopback mode at 64 kbit/s fixed data rate in UL, DL

The measurements can be performed on different radio access bearers (RAB) such as:

- ◆ SRB at 1.7 kbit/s, 2.5 kbit/s, 3.4 kbit/s, and 13.6 kbit/s
- ◆ AMR at 12.2 kbit/s, 10.2 kbit/s, 7.95 kbit/s, 7.4 kbit/s, 6.7 kbit/s, 5.9 kbit/s, 5.15 kbit/s, 4.75 kbit/s (codec set A to H, M) with selectable audio loopback

- ◆ Packet-switched connection at fixed data rate of UL/64 kbit/s and DL/384 kbit/s or 64 kbit/s UL and DL, or 384 kbit/s UL and DL, 64 kbit/s and 384 kbit/s in combination with HSDPA and HSUPA (optional)

An optional AMR speech codec for WCDMA that supports the above-listed data rates is also available. It allows audio measurements to be performed with the R&S®CMU200 audio board (option) or on an external audio analyzer, e.g. the R&S®UPL16.

The high flexibility of the signaling stack allows various parameters in the R&S®CMU200 MMI to be changed or different Node B configurations to be simulated via remote control.

Quality assurance

Due to its high measurement repeatability and accuracy, the R&S®CMU200 is the right choice to help ensure a consistently high level of quality. WCDMA-specific measurements such as BER/BLER and EVM, plus the full implementation of complementary (i.e. ACLR and OBW) measurements provide an excellent test platform for high-quality products. Unrivaled AF/audio and RF/fading performance allows test setups at a low price, with compact size and high test depth.

WCDMA in the R&S®CMU200

WCDMA development

The well-structured, user-friendly menu design and the clear-cut screen layout provide quick access to all features and ensures trouble-free monitoring of the device under test (DUT). The tester can be switched between 3GPP and general QPSK modes to increase the usability with DUTs under development. For analysis of the signaling messages between the UE and the R&S®CMU200, an optional message analyzer is available.

Production of mobile phones

The production of mobile phones requires time-efficient and cost-effective measurements that simultaneously ensure both high throughput and high yield. Owing to market-leading accuracy and the unique IEC/IEEE bus concept of the R&S®CMU200, these two goals can be easily achieved in production environments.

Repair applications (manufacturing and service centers)

With its outstanding versatility, the R&S®CMU200 is also a suitable tool for mobile phone troubleshooting. Four configurable RF ports and a built-in RF connector switch matrix (standard unit) are provided to enable flexible signal level ranges and switching. Since each R&S®CMU200 measurement menu allows an independent setting for the input and output ports, a phone fixture and spectrum analyzer probe can remain permanently connected to the R&S®CMU200.

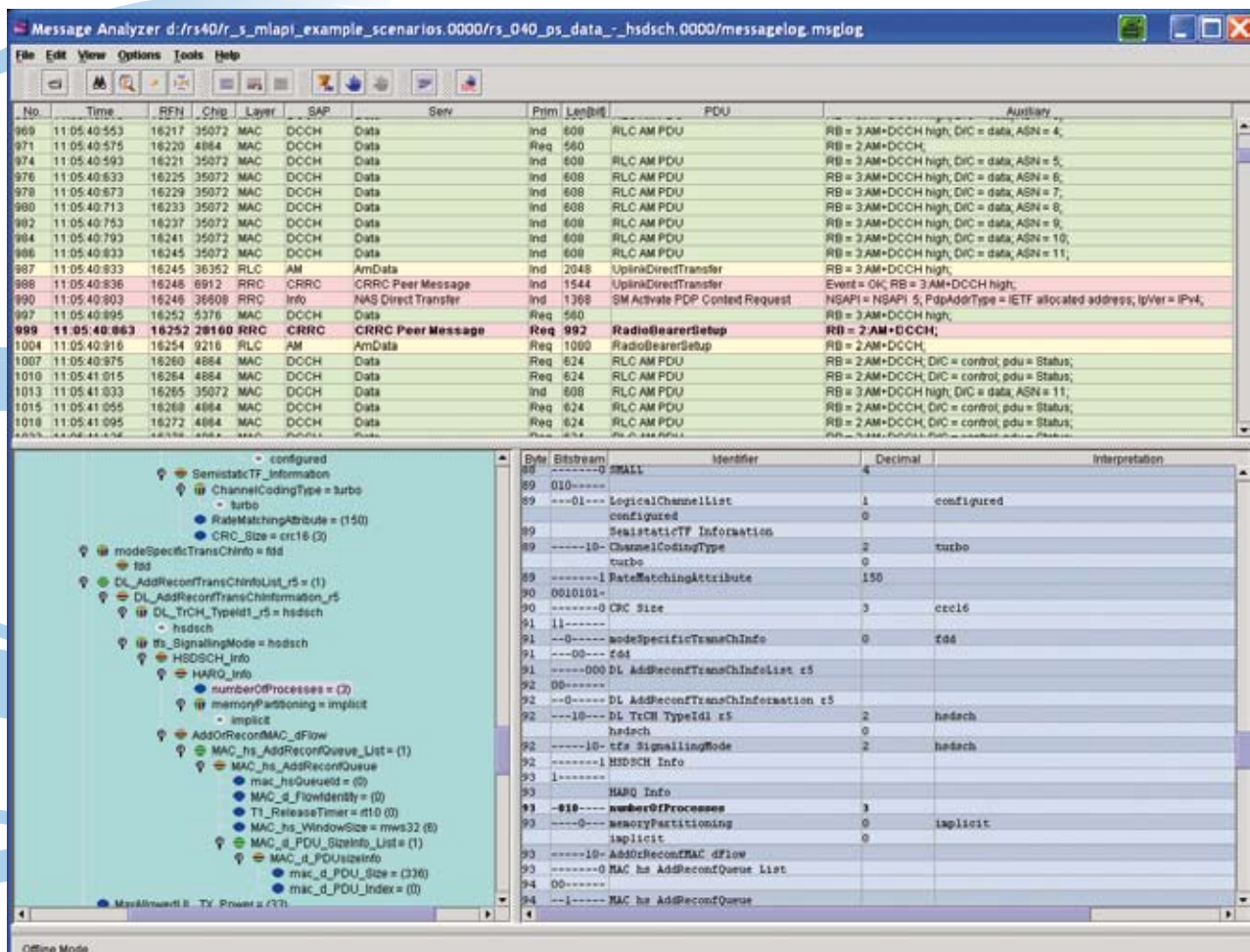

After the software has been ported to the mobile phone, users often want to record protocols to optimize internal processes or to perform an error analysis that may be necessary. The R&S®CMU246 message analyzer and recorder option allows all universal terrestrial radio access network (UTRAN) protocol layers to be recorded, which can then be used for more detailed analysis. When installed on an external PC and communicated to the R&S®CMU200 via an Ethernet connection, this powerful tool permits in-depth analyses, including transport layer analyses.

WCDMA highlights of the R&S®CMU200

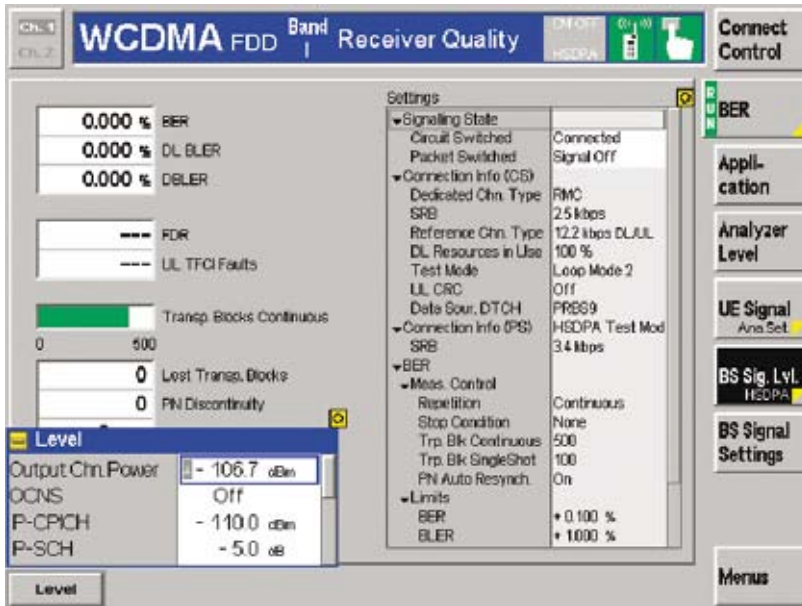

This measurement shows the receiver sensitivity measurement on a UE at -110 dBm P-CPICH in test-loop mode 2. In addition to the minimum DL power condition, the compressed mode can be selected to see if the same sensitivity is maintained with compressed mode. The R&S®CMU200 also provides a "lost transport blocks" counter for easier troubleshooting.

Switching standards

Fast switching between 3GPP FDD and any of the other numerous standards supported by the R&S®CMU200 is a standard feature of the instrument and can be achieved by simply pressing a button.

Versatile production test layouts are possible and true multimode test bays that utilize the flexibility and throughput of the R&S®CMU200 are no longer a concept of the future.

Multimode UE applications are possible using the handover capabilities of the R&S®CMU200 such as blind and compressed mode handover to GSM as well as blind handover or handover including inter-RAT neighbor cell measurement from GSM back to WCDMA.

- ◆ Benchmark-breaking ICE/IEEE bus speed (see highlights of base unit)
- ◆ Combined measurements, many different measurement modes
- ◆ Multiband/multimode testing
- ◆ Powerful signaling capabilities available: MOC, MTC, MIR, NIR, inter-frequency handover, inter-band handover, inter-RAT handover
- ◆ Display of UE capabilities
- ◆ Large selection of radio access bearers (RABs) with various data rates including video call in loopback mode
- ◆ Up to 384 kbit/s reference measurement channels (symmetrical and asymmetrical)
- ◆ 3GPP-conforming generation of OCNS (orthogonal channel noise simulation) and AWGN
- ◆ Separate and highly accurate level setting for individual DL code channels
- ◆ Simple voice test using AB/echo by tester; dedicated audio tests available (option)
- ◆ User-defined settings of RF-relevant signaling parameters
- ◆ ON/OFF time mask for open-loop power measurements including the system info settings
- ◆ Power vs slot menu for realtime measurement of RMS UE transmit power in up to 100 consecutive slots
- ◆ 3G dedicated trigger options such as IF power, signaling, slot, frame, preamble, PRACH message part, TPC, compressed mode, and change of TFC trigger
- ◆ External message analyzer for reading signaling message log files (option)
- ◆ Simple interactive operation in manual MMI
- ◆ Configuration of compressed mode for neighbor cell reports
- ◆ Handover and BER/BLER procedures during compressed mode

WCDMA evolution – high speed downlink packet access

High speed downlink packet access (HSDPA)

Fast, high-quality data services are already possible with WCDMA FDD Rel. 99 (frequency division duplex). As an extension of this functionality, 3GPP Rel. 5 (HSDPA) increases the data rate up to 14 Mbit/s by implementing new data transfer techniques. The increased data rate is made possible for two main reasons: Both communicating entities (Node B and UE) implement complex data transfer principles in layer 1, and, even more important, up to 15 new physical channels (HS-DSCHs) have been introduced in the downlink signal. The R&S[®]CMU200 takes part in this evolutionary trend by offering the software options for HSDPA in the signaling and non-signaling modes. All you need to do is install the key codes – no extra hardware is needed. The only requirement for the HSDPA software option is existing WCDMA functionality in the R&S[®]CMU200.

HSDPA functionality

The HSDPA software options enable the R&S[®]CMU200 to generate up to four HS-SCCHs and up to 15 HS-DSCHs in the downlink signal. Thus, the R&S[®]CMU200 can handle all HSDPA categories 1 through 12. Furthermore, the R&S[®]CMU200 hardware already supports HSUPA.³⁾

³⁾ More about the HSUPA capabilities in the following section.

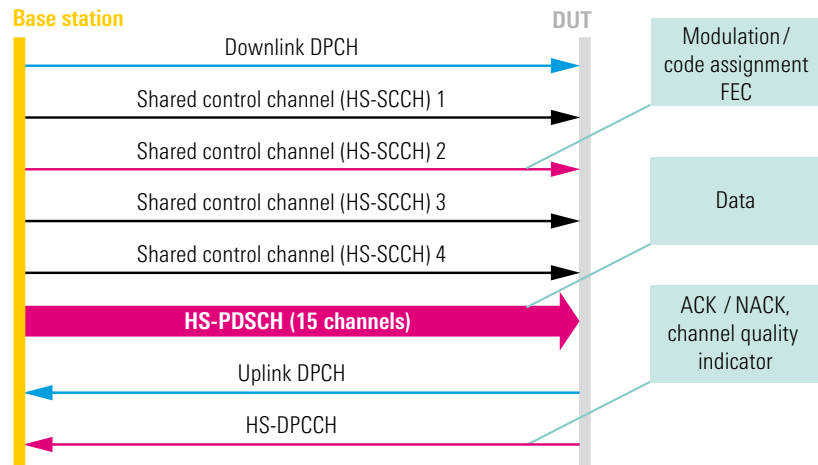

Channel structure of the physical channels with HSDPA.

Configuring the HSDPA channels

The R&S[®]CMU200 downlink signal can be configured in various ways, depending on the test purpose. This yields maximum flexibility. Each of the four HS-SCCH can be configured in power or channelization code, or they can be disabled. The HS-DSCH can also be changed with respect to power, channelization code, and data pattern, and it can be configured in three ways:

- ◆ In accordance with the fixed reference channels (H sets). You can select any of the 6 fixed reference channel configurations defined by 3GPP that use QPSK and 16QAM modulation
- ◆ In accordance with the CQI mapping table. Here, it is possible to use either a setting that corresponds to a fixed CQI value (1 to 30) or automatically change the setting between the corresponding parameters for a minimum and maximum CQI value in every TTI. You can also configure the R&S[®]CMU200 downlink signal in accordance with the received CQI in the uplink signal (follow UL CQI mode)

- ◆ User-defined configuration. Any of the following parameters can be adjusted individually: configuration of the downlink (HS-DSCH) channels including TTI distance, number of HARQ processes (1 to 8), transport block size, number of HS-DSCHs, modulation, redundancy versions (0 to 7), etc.

Non-signaling and signaling mode

Since HSDPA is primarily implemented in layer 1, interaction can already be provided between the UE and the tester in the non-signaling mode. It is e.g. possible in non-signaling already that the downlink signals (HS-DSCH) can be configured in accordance with the responses in the uplink signal HS-DPCCH (CQI, ACKs, and NACKs) (follow UL CQI mode).

All the described functionalities in the non-signaling mode are also provided in the signaling mode. This includes the above configuration and scheduling possibilities for the HSDPA channels.

This screenshot shows the ACK report menu, which counts the ACKs, NACKs, and DTXs for a specific HARQ process or for all HARQ processes. The throughput is calculated from the number of ACKs and the size of the transport blocks transmitted.

WCDMA FDD Band 1 Receiver Quality

Transmitted	ACK	NACK	DTX	Transmission
99.982 %	99.982 %	0.018 %	0.000 %	1st
0.018 %	100.000 %	0.000 %	0.000 %	2nd
0.000 %	---	---	---	3rd
0.000 %	---	---	---	4th
0.000 %	---	---	---	5th
0.000 %	---	---	---	6th
0.000 %	---	---	---	7th
0.000 %	---	---	---	8th

Measured Subframes: 49625
Median CQI: 28

Throughput	Minimum	Maximum	Scheduled
7203.566 kbit/s	100 %	7036.621 kbit/s	98 %
7204.022 kbit/s	100 %	7205.500 kbit/s	100 %
7205.500 kbit/s	100 %	7205.500 kbit/s	100 %

Max. pos. Throughput (based on settings)

Settings: HS-DSCH Config. Type: User Defined, Inter-TTI Distance: 1, No. of HARQ Processes: 6, Transport Block Size: 48, No. of Phys. Channel: 10, Modulation: 16QAM, IR Buffer Size: 22400 Bit, RV Coding Sequence: (0,2,5)

The HS-DPCCH logging application of the receiver quality measurement provides the ACK/NACK messages and reported CQI values that the UE returns in a sequence of 120 consecutive HS-DPCCH subframes (24 WCDMA frames).

WCDMA FDD Band 1 Receiver Quality

CPICH Timing Slot	SFN	ACK/NACK	CQI	
1	0	1130	NACK	13
2	3	1130	ACK	12
3	6	1130	NACK	11
4	9	1130	ACK	12
5	12	1130	ACK	11
6	0	1131	NACK	12
7	3	1131	NACK	14
8	6	1131	NACK	11
9	9	1131	ACK	12
10	12	1131	NACK	12
11	0	1132	NACK	12
12	3	1132	ACK	12
13	6	1132	ACK	11
14	9	1132	NACK	11
15	12	1132	NACK	12
16	0	1133	NACK	13

Settings: Signalling State: Registered, Established; Connection Info (CS): SRB: 3.4 kbps, Voice Source: Echo, Loopback Type: OFF; Connection Info (PS): SRB: HSDPA Test Mod, 3.4 Mbps; HS-DPCCH: Signal State: On, Number of HS-SCCH: 4; HS-FDSCH: Level: 0.0 dB, Channel Code: 2; HS-DSCH: Config. Type: User Defined, Inter-TTI Distance: 1, No. of HARQ Processes: 6, Transport Block Size: 48, No. of Phys. Channel: 5, Modulation: QPSK

This screenshot shows the reporting of the CQI and testing for two cases: whether more than 90 % of the reported CQIs (except DTX) are in the interval [median CQI - 2, median CQI + 2], and whether the HSPDSCH BLER on the median CQI is less than or greater than 10 %. If the BLER on the median CQI is < 10 %, the test is repeated at (median CQI + 2); otherwise, it is repeated at (median CQI - 1). The BLER at (median CQI + 2) must be > 10 %, and the BLER at (median CQI - 1) must be < 10 %. All this is implemented as a "one button press" operation for both cases, as well as the also specified fading case.

WCDMA FDD Band 1 Receiver Quality

HS-DPCCH CQI Table Config. Conformance Test: Chan/Freq: 9612 / 19224 MHz, Active CQI: 23, Start: 16

% UE Category: 12: 99.5 % / 21

% Table Config. Conformance Test: 30.2 % / 20

Chan/Freq: 9612 / 19224 MHz, Active CQI: 23, Start: 16

3.7 % / 23

21 Median CQI

2000 Measured Subframes

98.400 % CQI in Range

Median CQI - 1	Median CQI	Median CQI + 2	BLER
---	3.800 %	38.300 %	Pass
---	0.000 %	0.000 %	DTX
---	1000	1000	Measured Subframes

WCDMA evolution – high speed downlink packet access

New required measurements

In Rel. 99, the measurements that are defined in chapter 5 (transmitter characteristics) of TS 34.121 are performed using a 12.2 kbit/s reference measurement channel (RMC). This RMC defines one code channel on the I branch (DPDCH) and one code channel on the Q branch (DPCCH); both are continuously transmitted (except compressed mode cases). With Rel. 5, there is an additional code channel for the uplink, the HS-DPCCH. This code channel is on the Q branch in the case of the 12.2 kbit/s RMC and in the case of a signaling radio bearer (SRB). This code channel is not continuously transmitted, thus resulting in power changes that are not due to inner-loop power control. Furthermore, the HS-DPCCH slot boundaries are not necessarily aligned with the slot boundaries of the DPCH, which means that power transients may occur within the inner-loop power control cycle. The following properties of the HS-DPCCH pose new challenges for UE transmitter design:

- ◆ The HS-DPCCH channel is switched on and off as a function of the dynamic time scheduling in the downlink, i.e. it is switched on or off each time an HSDPA HARQ process is active and scheduled
- ◆ The slot boundaries of the channel are not synchronized with the time-slot pattern of the other uplink channels, but may be shifted by $n \times 256$ chips relative to these

Transmitter measurements

The characteristics mentioned above place new demands on the RF functionality of DUTs, which in turn calls for an expansion of 3GPP TS34.121 RF test definitions. For example, an HS-DPCCH that is

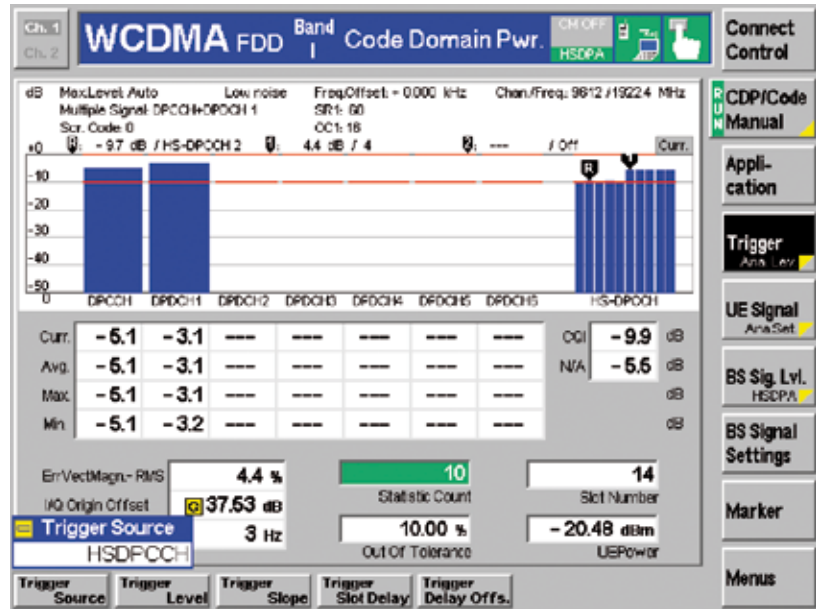

The measurement diagram in code domain power measurement shows the DPCCH, the DPDCH, and the HS-DPCCH. The measurement for the HS-DPCCH is divided into ten bars which represent the powers of the ten HS-DPCCH symbols in the DPCH slot. Since the power of the HS-DPCCH changes in line with its content, the timing offset between the HS-DPCCH and the DPCH can be set to e.g. 50% alignment. Thus, the power change between two slots transmitting different data on the HS-DPCCH can be seen in the center of the DPCH slot. In this example, the first five symbols transmit ACKs or NACKs and the next five symbols contain CQIs.

out of tolerance may produce undesired spectral components, which may affect results both in modulation and spectral (ACLR, SEM) measurements. The power setting of the UE in limit ranges and transitional regions, for example at maximum power, must correspond to a defined nominal behavior. The R&S®CMU200 can perform measurements (modulation, spectrum, power, etc) using a time-variable HS-DPCCH trigger. By means of this trigger, the additional RF component introduced by the HS-DPCCH uplink signal can be included or omitted in measurements. The R&S®CMU200 also supports dedicated HSDPA transmitter measurements such as HS-DPCCH time mask, EVM&PhD with HS-DPCCH and CDP versus time. Moreover, nominal beta and delta factors can be set on the R&S®CMU200 for determining the code power of each uplink code channel (DPCCH, DPDCH, and HS-DPCCH).

Performance measurements

In addition to the transmitter characteristics, items defined in chapter 9 of 3GPP TS34.121 related to performance tests are also covered in the R&S®CMU200.

In the throughput measurement, the R&S®CMU200 provides a receiver sensitivity measurement by counting the ACKs, NACKs, and DTXs for a specific HARQ process or for all HARQ processes. The throughput is calculated from the number of ACKs and the size of the transport blocks transmitted.

The R&S®CMU200 can be configured in such a manner that its downlink channels (HS-DSCH) correspond to the UE category and to the CQI returned from the UE (follow UL CQI mode). Depending on the feedback from the UE (ACKs, NACKs, or DTXs), the R&S®CMU200 can send a different redundancy version of the

HSDPA highlights of the R&S®CMU200

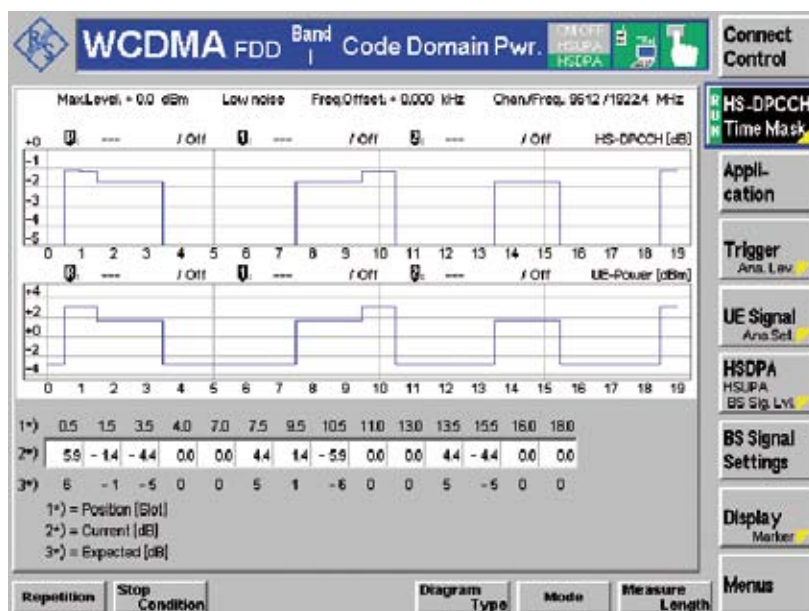

The HSDPA measurement HS-DPCCH power control has been redefined in the 3GPP TS34.121/5.7A specification to test the UL power variation due to the transmission of HS-DPCCH in combination with inner loop power control. The new measurement in the R&S®CMU200 allows the measurement of the resulting power variation on the specified 17 (for ILP algorithm 1) or 14 (for ILP algorithm 2) dedicated points on the 12 ms cycle. In the screenshot, the measurement for ILP algorithm 2 is shown.

data package, repeat the package with the same redundancy version or continue with a new package. During this scenario, several measurements or reports are performed in parallel:

- ◆ Percentage of transmissions that were transmitted or retransmitted (ACKs and NACKs) or not answered at all (discontinuous transmission, DTX)
- ◆ Values are specified for the initial transmission as well as for the 1st through 7th redundancy versions
- ◆ Median of the CQI values reported by the UE
- ◆ Throughput analysis

Furthermore, chapter 9 of 3GPP TS 34.121 defines various tests for checking the reporting of CQI under AWGN propagation conditions or under fading propagation conditions. These measurements can be performed in the R&S®CMU200 as a “one button press” operation by means of the CQI reporting test. In the case of AWGN, the measurement is performed in two stages:

In the first stage, the R&S®CMU200 checks whether more than 90 % of the

reported CQIs (except DTX) are in the interval (median CQI – 2, median CQI + 2) and whether the BLER on HS-PDSCH at median CQI is greater than or less than 10 %. If the BLER on the median CQI is < 10 %, the test is repeated at (median CQI + 2); otherwise, it is repeated at (median CQI – 1). The BLER at (median CQI + 2) must be > 10 %, the BLER at (median CQI – 1) must be < 10 %. Similarly, the CQI detection performance test under conditions of fading is also implemented as “one button press” operation in the R&S®CMU200. The R&S®CMU200 also provides an additional HS-DPCCH logging function. This function can be used to track the HS-DPCCH in order to verify the response to the HARQ process scheduled by the R&S®CMU200. The logged HS-DPCCH data may also be compared to logging data from the UE. The log contains the ACK/NACK and CQI data for 120 consecutive HS-DPCCH subframes on the MMI and even more on the remote interface. The log starts with subframe 0 of the next system frame or can be triggered to start at a specific system frame number (SNF).

- ◆ Generation of up to four HS-SCCHs and up to 15 HS-DSCHs; configuration of downlink HS-DSCHs in three different ways:
 - 3GPP-compliant fixed reference channels (H sets for QPSK or 16QAM)
 - In accordance with CQI mapping table (1 to 30)
 - User-defined (providing full flexibility)
- ◆ Force NACK function to test the performance of the UE by sending corrupted blocks in the downlink
- ◆ CQI interaction, in which the R&S®CMU200 generates the downlink signal (HS-DSCH) in accordance with the received uplink CQI (follow UL CQI)
- ◆ Transmitter measurements by means of the power, modulation, code domain power, and spectrum measurements in the presence of HSDPA (dedicated HS-DPCCH trigger) in accordance with chapter 5 of 3GPP TS 34.121
- ◆ Receiver measurements by counting ACKs, NACKs, DTXs for a specific HARQ process or all HARQ processes and data throughput
- ◆ CQI reporting test and HS-DPCCH logging tool
- ◆ Configuration capabilities for the power offset parameters ΔACK , ΔNACK , and ΔCQI to control the power of the HS-DPCCH
- ◆ DPCH timing offset between the DPCH and the HS-DPCCH
- ◆ Code domain power versus time measurement
- ◆ Multiple RAB test mode types:
 - 12.2 kbit/s RMC + HSDPA (with closed loop mode 1 RLC TM and loop mode 2)
 - 3.4 kbit/s SRB RAB + HSDPA
 - 12.2 kbit/s RMC + HSDPA in line with 3GPP TS34.108
 - 12.2 kbit/s (+HSDPA) where the HSDPA part is paged independently as a PS RAB on top of RMC

WCDMA evolution – high-speed uplink packet access

High-speed uplink packet access (HSUPA)

Following the increase of downlink data rates with HSDPA, higher uplink data rates are now in focus with HSUPA or enhanced uplink (EUL). This extension to WCDMA FDD Rel.99 is defined in 3GPP Rel. 6 and increases the uplink data rate from 384 kbps (WCDMA) to 5.76 Mbps. To achieve this, data transfer technologies similar to those in HSDPA are used in the uplink. This includes up to four new physical data channels (E-DPDCHs) and a new physical control channel (E-DPCCH) in the uplink as well as complex data transfer principles in layer 1 such as the scheduling of the uplink data rate by means of signaled grant values. HSUPA also allows the dynamic adaptation of the inter-TTI distance, which means that data blocks can be sent every 10 ms or, alternatively, every 2 ms.

Once again, the R&S®CMU200 is setting new standards by offering HSUPA as a software option in the non-signaling and signaling modes. All you need to do is install the keycode – no extra hardware is required. As is already the case with HSDPA, the only requirement for the HSUPA software option is existing WCDMA functionality in the R&S®CMU200.

HSUPA functionality

The HSUPA software option enables the R&S®CMU200 to generate all the new downlink channels that are needed for HSUPA such as the E-AGCH for sending absolute grant values to the DUT, the E-RGCH for the relative grant values, and the E-HICH for sending HARQ feedback to the UE. By means of this functionality as well as by signaling different E-DPCCH

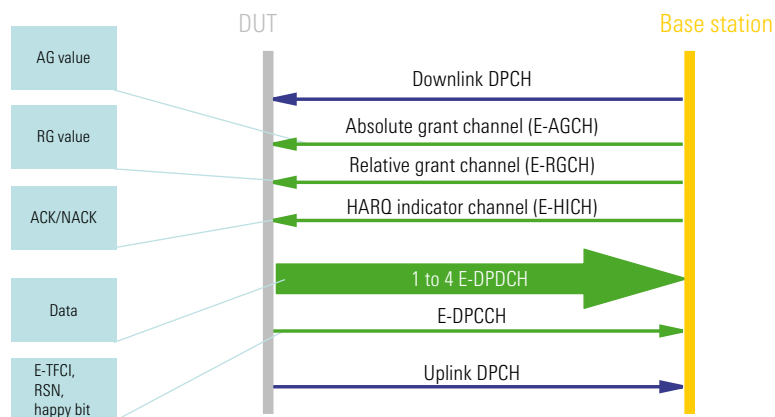

Channel structure of the physical channels with HSUPA

gain factors and reference E-TFCIs to the UE, the uplink channels can be influenced.

In addition, all general RF measurements such as power, modulation, spectrum, and code domain power measurements are updated in order to take the new uplink channels E-DPCCH and E-DPDCHs into account. Moreover, specific HSUPA measurements based on the performance measurement requirements in 3GPP TS 34.121 chapter 10 are implemented, and the content of the control channel sent by the UE (E-DPCCH) can be logged in detail. Plus, throughput measurements on the physical layer and on the RLC layer are also possible with the R&S®CMU200.

Configuring the HSUPA channels

Various configuration alternatives for the downlink channels are provided that influence the channel situation on the uplink and the resulting uplink data rate. These channels are the absolute and relative grant channels E-AGCH and E-RGCH. The R&S®CMU200 can set up different absolute grant patterns of different lengths and with different grant values which can be user-defined or set

according to predefined patterns. These grant values can be sent to the UE continuously (absolute grant update) or just once. Furthermore, the relative grants can be used to vary the E-TFCI that is used and therefore the UL data rate. Again, various predefined or user-definable patterns are supported for the E-RGCH content.

Additionally, the HARQ feedback from the R&S®CMU200 to the UE can be set up. The content of the E-HICH can, for example, be set such that the R&S®CMU200 decodes the received package and answers CRC errors with NACK to simulate real-world conditions. Alternatively, predefined ACK/NACK/DTX patterns can be used for the E-HICH feedback.

Non-signaling and signaling mode

As in all function groups in the R&S®CMU200, HSUPA is implemented in the non-signaling as well as in the signaling domain. The focus in HSUPA non-signaling, which is typically used in production concepts, is to perform standard RF measurements such as modulation quality, spectrum, and power, in the

WCDMA evolution – high-speed uplink packet access

presence of HSUPA channels. In signaling, more variety is possible and full flexibility of the R&S[®]CMU200 can be used to configure the downlink channels and analyze the uplink signal coming from the DUT. This goes beyond the standard RF measurements and also includes HSUPA performance tests as specified in 3GPP TS 34.121 chapter 10.

New required measurements

Rel. 6 of the 3GPP TS34.121 describes different measurements for HSUPA in chapter 5 (transmitter characteristics) and chapter 10 (performance requirements for HSUPA). All these tests are to be carried out in HSPA test mode connection that includes both the HSDPA test mode and the HSUPA test mode. In the R&S[®]CMU200, various test mode RABs are supported.

On the transmitter side, the tests are standard RF tests such as power and spectrum measurements in the presence of the HSUPA channels. For the performance tests, the decoding performance of the UE for the different DL channels under conditions of fading is tested. These tests and the required test mode RAB setups are supported by the R&S[®]CMU200 and will be expanded over time. At present, no dedicated receiver measurements are specified for HSUPA.

Furthermore, the test of the physical layer throughput is certainly of interest and of importance. Also, when real user data is used for traffic in an end-to-end connection between a client and a server (e.g. IP-based applications such as FTP or video streaming), the throughput evaluation in the uplink and downlink over time is of great interest. All of this is also easily possible on the R&S[®]CMU200.

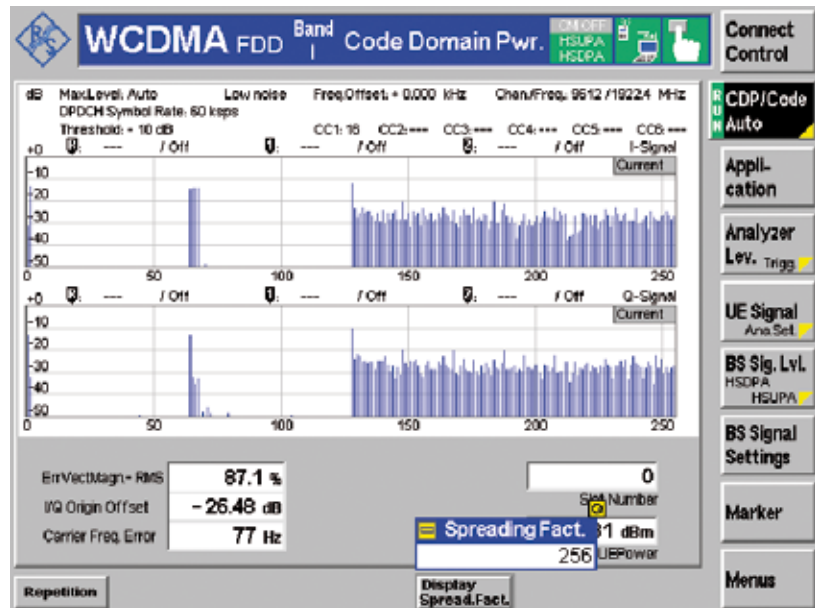

In the code domain power measurement on the R&S[®]CMU200, the user can easily verify which code channels are present in the uplink signal coming from the DUT. This is a valuable tool especially in R&D on early UE designs. Shown above is a signal that contains WCDMA channels (DPDCH and DPCCH) as well as HSDPA (HS-DPCCH) and HSUPA channels (E-DPCCH and E-DPDCHs).

Transmitter measurements

In HSUPA operation, up to five additional uplink channels are in place; and in test mode connections, the HSDPA uplink channel HS-DPCCH with its special characteristics is also present. This fact calls for additional measurements on the transmitter of the mobile phone. Specifically, measurements that check the spectral behavior of the UE are of interest. Furthermore, the maximum output power of the UE once again needs to be checked against the defined nominal behavior.

The R&S[®]CMU200 can perform the measurements for the transmitter characteristics as defined in the 3GPP TS34.121 RF test specification. All other standard transmitter measurements on the R&S[®]CMU200, e.g. modulation or code domain power measurements, take the additional uplink channels into account as well. The code domain power measurements in particular yield valuable additional information about the new channels such as the ap-

plied uplink power influenced by the gain factors for each code channel.

Performance measurements

In addition to the transmitter characteristics, items defined in chapter 10 of 3GPP TS 34.121 related to HSUPA performance tests are also covered in the R&S[®]CMU200.

In the E-HICH detection performance measurement, the receive characteristics of the E-DCH HARQ ACK indicator channel (E-HICH) based on the determination of the missed ACK and false ACK probability are evaluated as defined in TS34.121/10.2.1. By evaluating the UE-reported radio sequence number (RSN) on the UL E-DPCCH, the E-HICH detection performance is measured correctly regardless of the DL E-HICH pattern. According to the 3GPP specification, the DL E-HICH has to transmit all ACKs or all DTXs, but the R&S[®]CMU200 can also be set to transmit all NACKs or an alternating pattern as well as a real-world scenario "react on UL CRC".

HSUPA highlights of the R&S®CMU200

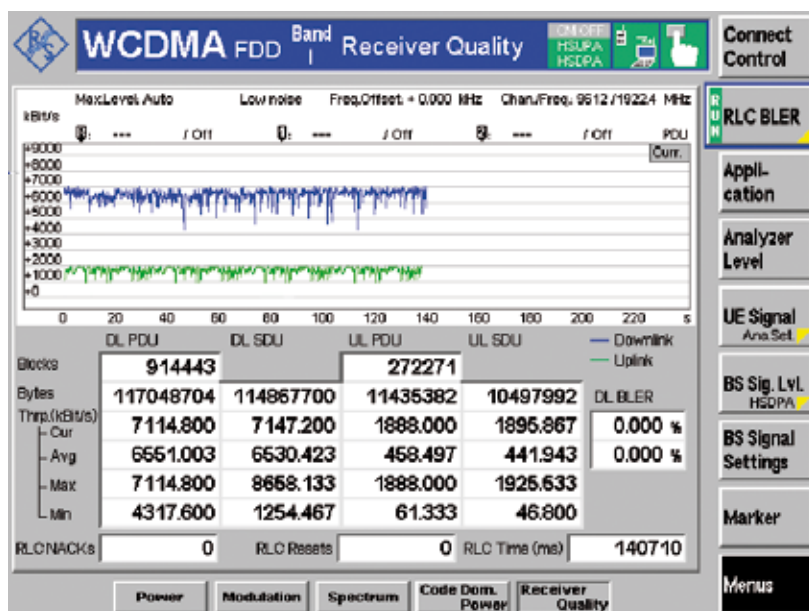

Full data rate HSPA throughput evaluation on the RLC layer in the uplink and downlink over time is easily possible on the R&S®CMU200 application testing solution for 3G when real user data is used for traffic in an end-to-end connection between a client and a server (e.g. IP-based applications such as FTP or video streaming).

In the E-HICH performance measurement, a layer 1 throughput measurement based on the analysis of the uplink E-TFCIs that are used is also included in the R&S®CMU200. This measurement also performs a CRC check of the received transport blocks to make sure that only correct UL data is taken into account for the throughput.

In the A-GCH detection performance measurement, the receive characteristics of the E-DCH absolute grant channel (E-AGCH) based on the determination of missed detection probability is evaluated as defined in TS34.121/10.4.1. To do this, the tester has to continuously transmit a defined sequence of absolute grant values (AG) in the DL E-AGCH, where the DUT has to follow the AG settings with the correct UL E-TFCIs on the UL E-DPCCH. The missed detection probability is evaluated based on the received E-TFCIs.

In the R&S®CMU200, a happy counter makes sure that only TTIs where the UE is unhappy are taken into account in order to guarantee that the UE is using the

granted E-TFCIs. Since the UL E-TFCI to be used depends on various additional parameters besides the AG value, the R&S®CMU200 calculates the expected E-TFCIs automatically based on all relevant settings, which makes this measurement very convenient to use. Moreover, the measurement can be used as a general UL E-TFCI histogram and any E-AGCH values can be used. This also makes it possible to perform measurements such as the TS34.121/5.2B maximum output power with HS-DPCCH and E-DCH, where the UL E-TFCI that is used is of interest.

As an additional measurement application, the R&S®CMU200 makes it possible to log and decode the content of the UL E-DPCCH in detail over 1000 TTIs. All transmitted information such as the UL E-TFCI (transport format combination identifier) that is used, indicated RSN (radio sequence number indicating retransmission or new transmission), and the happy bit (reveals whether the UE is happy with the granted recourse) are displayed.

- ◆ Generation of E-AGCH, E-RGCH, and E-HICH channel with full flexibility with regard to grant patterns and feedback pattern
- ◆ E-HICH interaction, where the R&S®CMU200 sends the answer in accordance with the received uplink signal (react on UL CRC mode)
- ◆ Transmitter measurements maximum output power, spectrum emission mask, and ACLR in accordance with chapter 5 of 3GPP TS 34.121
- ◆ Receiver measurements by evaluating the data throughput based on uplink E-TFCIs used and CRC check on the UL data
- ◆ E-DPCCH logging capability for in-depth analysis
- ◆ Performance measurements on E-HICH and E-AGCH channels to verify UE detection performance
- ◆ Configuration capabilities for the power offset parameters ΔE -DPCCH and reference E-TFCIs to control the power of the uplink channels
- ◆ Multiple test mode RAB types:
 - 12.2 kbit/s RMC + HSPA (with closed loop mode 1 RLC TM and loop mode 2)
 - 3.4 kbit/s SRB RAB + HSPA
 - 12.2 kbit/s RMC + HSPA according to 3GPP TS34.108
 - 12.2 kbit/s (+HSPA), where the HSPA part is paged independently as a PS RAB on top of RMC

TDMA in the R&S® CMU200

TDMA overview

The broad acceptance of TDMA (IS-136) is based on its very flexible and powerful technology as well as on its compatibility with AMPS, which is widespread. Derived from analog AMPS, the TDMA standard is ready for step-by-step evolution to the third generation of mobile radio technology. This fact shows the need for a test instrument that is flexible enough to cover all future needs as well as the current standards.

For TDMA (IS-136) signaling functionality, the R&S® CMU200 requires the universal signaling unit (R&S® CMU-B21) as well as the software option R&S® CMU-K27 for the cellular band or R&S® CMU-K28 for the PCS band.

Due to the highly user-friendly menu concept, the R&S® CMU200 provides quick access to all required measurements, optimizing handling and thus efficiency.

Signaling mode

The R&S® CMU200 simulates a TDMA base-station RF interface including the signaling protocol so that a mobile phone can be tested with regard to different signaling parameters. All necessary network and base-station parameters can be set, such as control and traffic channel configuration, neighboring channels setup, etc. A MAHO report can also be generated.

Non-signaling mode

The non-signaling mode is for generating and analyzing TDMA (IS-136) signals in the frequency range from 10 MHz to 2.7 GHz. The R&S® CMU200 provides TDMA-specific measurements such as:

- ◆ Power
- ◆ Modulation
- ◆ Spectrum
- ◆ Power versus time
- ◆ BER

TDMA (IS-136) development

With its superb versatility, the R&S® CMU200 is the most suitable tool for the development of mobile phones. Four configurable RF connectors are provided to enable flexible signal generation and analysis. The power meter can evaluate signals in a range from -80 dBm to +47 dBm, whereas the generator outputs signals from -130 dBm to +13 dBm. The clearly structured and user-friendly menu together with the clear-cut screen layout provide quick access to all features and ensure trouble-free monitoring of the device under test.

Quality assurance

Due to its high measurement repeatability and accuracy, the R&S® CMU200 is the right choice to ensure a consistently high level of quality in production. TDMA-specific measurements such as BER, error vector magnitude (EVM) and EVM10, where only the first 10 symbols are taken into account, provide an excellent test platform to ensure the production of high-quality devices.

Production of mobile phones

The production of mobile phones requires time-efficient and cost-effective means that ensure both high throughput and state-of-the-art accuracy. Owing to the unique IEC/IEEE bus concept of the R&S® CMU200, these two goals can be easily achieved in production lines. The intelligent handling of the received GPIB commands optimizes the measurement speed for all TDMA-specific measurements. In practice, this will mean significantly shorter test time and enhanced test yield.

Acoustic measurements

The implemented ACELP speech coder is able to encode and decode real audio signals and allows the R&S® CMU200 to be used also in real acoustic measurement applications. This is equivalent to the CDMA2000® and GSM implementation of the R&S® CMU200. The TDMA speech coder provides analog inputs and outputs and a connector for an external handset. It requires the hardware option R&S® CMU-B52 and can also be combined with the internal Audio Analyzer/Generator R&S® CMU-B41.

The mobile phone reports the received signal strength (RSSI) of the observed channels back to the R&S® CMU200 where the RSSI is displayed in the MAHO report list. It is possible to configure the neighboring channels in the network setup. The reported BER can also be monitored.

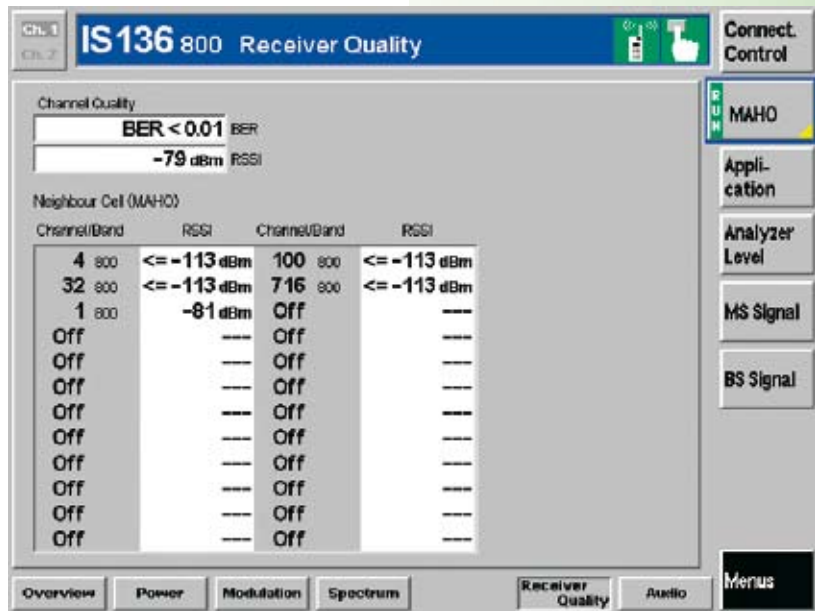

The modulation menu allows the phase error, frequency error and the error vector magnitude to be measured. The measurement results are displayed graphically. Additional measurements such as amplitude droop and timing error are taken as well and displayed numerically in the same screen.

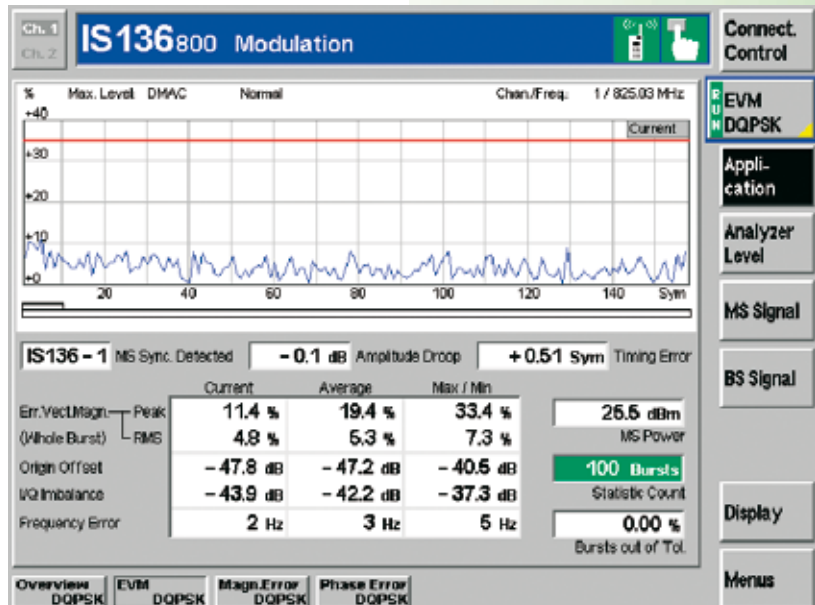

In the power menu, the mobile phone output power of the short burst or the normal burst is displayed. The R&S® CMU200 also enables leakage power measurements which indicate the mobile phone power output in timeslots not used.

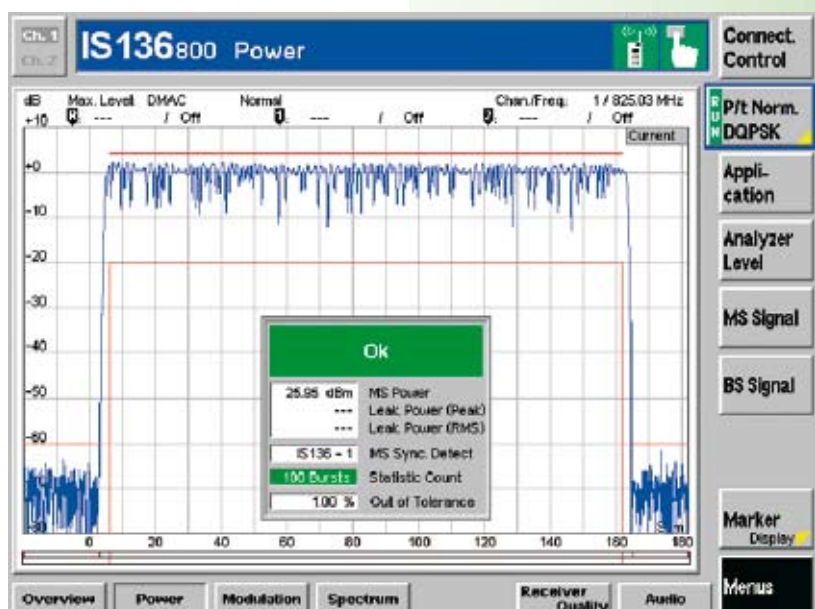

Handoffs

Handoffs are part of the IS-136 specification. Handoffs between PCS and cellular bands as well as from and to AMPS are defined and have to be tested. The R&S® CMU200 supports IS-136 handoffs from 800 MHz to 1900 MHz (interband handoff) and vice versa. Handoffs from 1900 MHz or 800 MHz to AMPS and vice versa are also possible (intermode hand-off) with the R&S® CMU200.

Switching standards

The flexibility of the R&S® CMU200 makes for quick and simple switching between two different standards. This is very important for IS-136, which is a dual-mode standard containing a digital (TDMA) and an analog mode (AMPS). The handoff between TDMA and AMPS can be achieved by simply pressing a button. This results in a very versatile test concept to improve the flexibility and throughput of production lines.

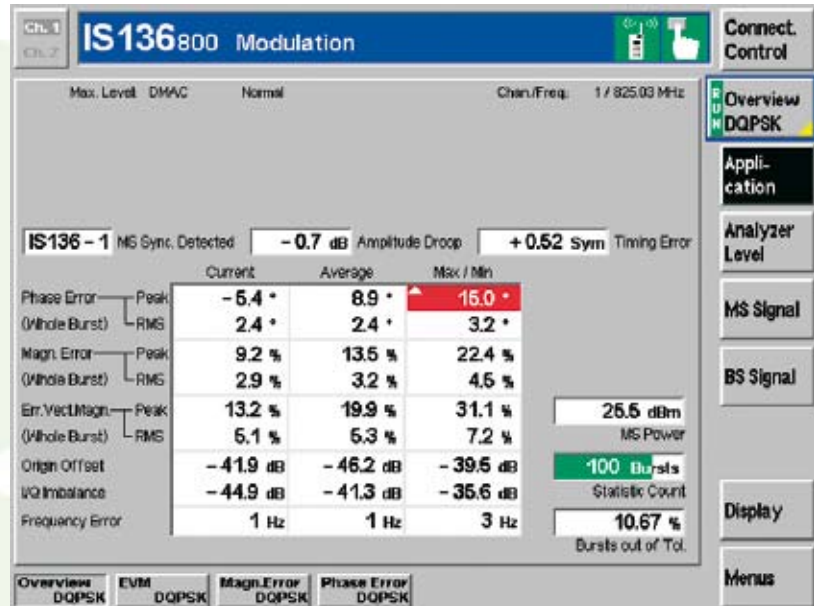

In the modulation overview menu, error vector magnitude (EVM), phase error and magnitude error are measured simultaneously and displayed in a numeric table. The user can choose either EVM, where the entire burst is considered, or EVM10, where only the first ten symbols are taken into account.

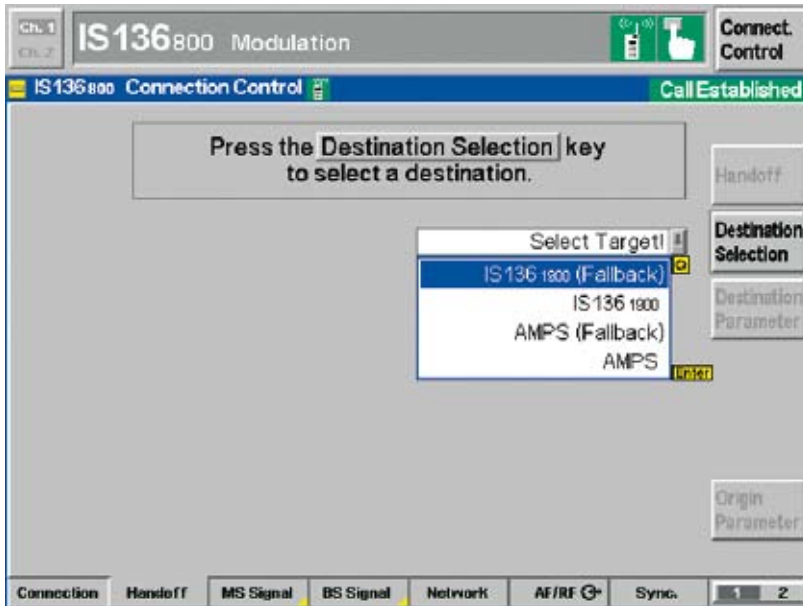

Handoffs from cellular band (800 MHz) to PCS band (1900 MHz) can be tested as well as to and from AMPS. Before handoff to a new network, the parameters for the target network can be set. This results in a large variety of different test scenarios.

TDMA highlights of the R&S®CMU200

Basic features

- ◆ Call to or from mobile phone
- ◆ Handoff to AMPS
- ◆ Dual-band handoff

Signaling measurements

- ◆ MAHO report
- ◆ Power versus time
 - Short burst
 - Normal burst
- ◆ Modulation
 - Phase error
 - Magnitude error
 - EVM/EVM10
 - Overview of phase/magnitude and EVM simultaneously
- ◆ Spectrum
 - Adjacent channel power due to switching or modulation
- ◆ Overview
 - Signaling information

Non-signaling measurements

- ◆ Modulation
- ◆ Spectrum
- ◆ Power versus time
- ◆ BER

AMPS in the R&S® CMU200

AMPS overview

Analog AMPS (advanced mobile phone system) is a standard system for analog mobile phone service in the United States and is also used in other countries. It is based on the frequency spectrum allocation for cellular service established by the Federal Communications Commission (FCC) in 1970. Introduced by AT&T in 1983, AMPS became the most widely deployed cellular system in the United States.

AMPS options

Although AMPS is a first generation analog standard, a substantial demand for mobile radio testers covering this standard will continue to exist in the future. Especially in the United States, dual-mode CDMA2000®/AMPS and TDMA/AMPS phones are very common.

By combining the digital standards with analog AMPS, the network operators offer their customers the advantages of the digital standards and ensure nearly 100% coverage in North America. As a consequence, Rohde & Schwarz is offering analog AMPS in addition to the digital standards TDMA and CDMA2000®. These options add analog AMPS functionality to the R&S® CMU200 base unit:

- ◆ R&S® CMU-B21 (universal signaling unit)
- ◆ R&S® CMU-B41 (audio generator/analyzer)
- ◆ R&S® CMU-K29 (AMPS test software)

The hardware options R&S® CMU-B21 and R&S® CMU-B41 are suitable for other standards as well.

AMPS measurements and features

As for other standards, there are two categories of AMPS measurements:

- ◆ Transmitter tests for verifying the transmit part of a mobile phone
- ◆ Receiver tests for verifying the receive part of a mobile phone

AF level search routine

The AF level search routine in the TX test menu allows the user to set the desired frequency deviation of the mobile phone transmitter at a keystroke, the level of the R&S® CMU200 modulation generator being automatically corrected.

Sensitivity search routine

The sensitivity search routine in the RX test menu automatically searches for the receiver input level at which a selectable SINAD of the demodulated signal can still be attained.

The following lists provide an overview of the most important tests implemented in the R&S® CMU-K29 option.

Transmitter measurements

- ◆ Carrier power
- ◆ Carrier frequency error
- ◆ SAT frequency error/peak deviation
- ◆ ST frequency error/peak deviation
- ◆ Modulation noise and distortion
- ◆ Hum and noise
- ◆ Electrical AF response
- ◆ Modulation distortion
- ◆ Residual AM

Receiver measurements

- ◆ Sensitivity
- ◆ Hum and noise
- ◆ SINAD
- ◆ Distortion
- ◆ AF voltage
- ◆ Electrical AF response
- ◆ Residual AM
- ◆ Audio deviation

AMPS highlights of the R&S®CMU200

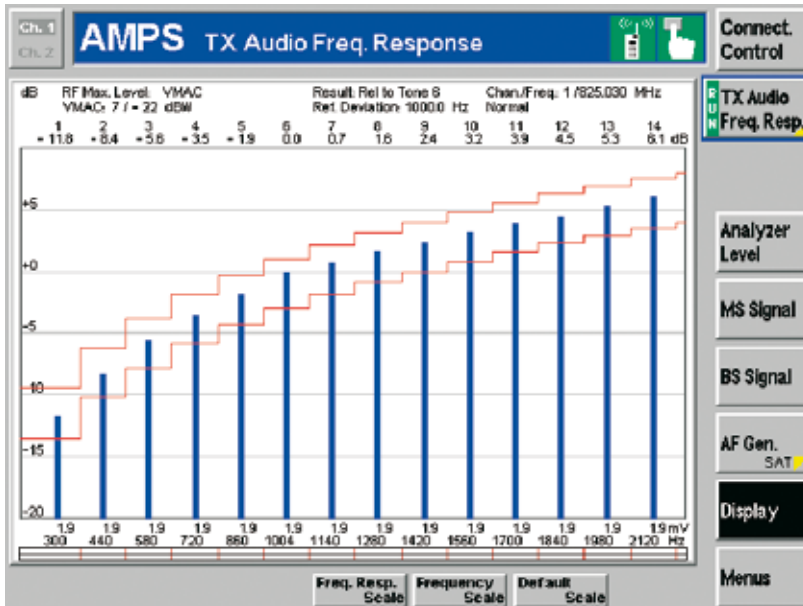

TX AF response measurement: the pre-emphasis characteristic of the mobile phone transmitter is verified by a single-shot measurement.

All the filters required for the measurements are of course preconfigured in line with specifications, but their settings can be modified for individual measurements. The RX and TX electrical AF response measurements in AMPS are usually defined as frequency sweep versus AF range. The R&S®CMU200 offers a much faster and more modern alternative.

Using the TX and RX AF response menus of the R&S®CMU200, the AF response is measured simultaneously at 20 test points with user-programmable level and frequency and then checked against specified tolerances (see screenshot above).

Benefits of base unit

- ◆ Platform supporting CDMA2000®, TDMA and AMPS in one box
- ◆ Wide frequency range allowing dual-mode/dual-band testing required for CDMA2000® and TDMA
- ◆ See base unit section

AMPS features

- ◆ Powerful signaling capabilities
- ◆ Base station simulation
- ◆ Mobile or base station originated call connect/disconnect
- ◆ Short measurement time ensuring high throughput
- ◆ Combined measurements
- ◆ Benchmark-breaking IEC/IEEE bus speed
- ◆ Simple interactive operation, standardized MMI
- ◆ No specialized network knowledge required
- ◆ Various handoffs from CDMA2000®/TDMA and to TDMA supported

CDMA2000[®] 1xRTT in the R&S[®]CMU200

CDMA2000 1xRTT overview

CDMA2000 1xRTT is member of the CDMA2000 family of standards. CDMA2000 1xRTT (CDMA2000 1x) was recognized by the International Telecommunications Union (ITU) as an IMT-2000 standard in November 1999, and with the start of commercialization in October 2000 it was the first IMT-2000 technology deployed worldwide.

CDMA2000 1x benefited from the extensive experience acquired through several years of operation of cdmaOne systems. CDMA2000 1x handsets are backwards compatible with cdmaOne systems.

The designation "1xRTT" (1x Radio Transmission Technology) is used to identify the version of CDMA2000 radio technology that operates in a single 1.25 MHz radio channel (compared to three 1.25 MHz channels in 3xRTT). 1xRTT almost doubles voice capacity over IS-95 networks. Although capable of higher data rates, most deployments have limited the peak data rate to 153 kbit/s.

CDMA2000 1x networks are not only widely used in North and South America as well as in Asia, but CDMA2000 1x is also becoming increasingly important in Northern and Eastern Europe in the 450 MHz band. More than 250 operators worldwide have selected CDMA2000, and there are over 380 million subscribers using CDMA2000 (1xRTT and 1xEV-DO).

CDMA2000 1x operates worldwide in different frequency bands. Presently, the standard defines 17 different band classes, all of which are covered by the R&S[®]CMU200. Additional band classes can be integrated easily as the market evolves.

CDMA2000 1x functionality

Implementation of the CDMA2000 1x standard in the R&S[®]CMU200 is currently based on TIA/EIA-2000 Rev. 0; the tests provided by the R&S[®]CMU200 are currently based on TIA/EIA-IS-98-F. Regular adaptations to new releases will be made available as the market requires. The measurement concept in the R&S[®]CMU200 is based on ProbeDSP™ technology, which permits high-speed measurements. The emphasis is on fast measurements and clear and concise representation.

Like all mobile radio networks supported by the R&S[®]CMU200, there is a distinction between signaling and non-signaling mode. All major network, base station, and link parameters are clearly organized and configurable. The implementation of CDMA2000 1x in the R&S[®]CMU200 takes into account all important features of the standard.

For instance, the R&S[®]CMU200 supports the quick paging channel (QPCH) which is used to extend battery lifetime. In addition to the normal configuration, it is possible to define in the test setup whether or not the QPCH addresses the DUT. This ensures that the mobile phone observes the QPCH instead of the normal pilot channel. Above all the configuration change indicator (CCI) bits can be set to enable or disable.

CDMA2000 1x forward power control enables the mobile station to control the output power of the base station in the dedicated channels. Measurements in the R&S[®]CMU200 allow a comprehensive function check of this CDMA2000 1x feature. The R&S[®]CMU200 supports also new features of the standard such as MEID emulation or the call configuration and setup in service option 68, i.e. a voice call based on the EVRC-B speech codec.

Signaling mode

In signaling mode, all major parameters of a mobile phone can be checked with a connection established. The R&S[®]CMU200 simulates a CDMA base station, allowing the mobile phone to be tested as in a real network. The signaling mode is not only needed in production (e.g. final test) but also in service and development.

The R&S[®]CMU200 provides a large set of different connection types (service options), making the tester ideal for both R&D and production purposes.

The following service options are currently supported:

- ◆ Test loop service options: SO 2, SO 9, SO 55
- ◆ Speech service options: SO 1, SO 3, SO 17, SO 68, SO 0x8000
- ◆ Test data service option: SO 32
- ◆ IP end-to-end data connection: SO 33
- ◆ Short message service (SMS): SO 6, SO 14

The range of functions is as follows:

- ◆ Power measurements
 - Minimum/maximum output power
 - High-speed narrowband power
 - Gated output power
 - Open-loop time response
 - Access probe power
 - Standby power
 - Range tests by using user-configurable power control bit patterns
- ◆ Modulation (both RC1/2 and RC3/4)
 - Error vector magnitude (EVM), magnitude error, phase error, waveform quality, carrier feed-through, frequency error
- ◆ I/Q analyzer
 - Eye diagram, constellation/vector diagram

The Message Monitor (R&S®CMU-B87 option) captures, interprets, and displays the CDMA2000 1x forward and reverse link messages between an R&S®CMU200 and a mobile station. For SO 33 calls, it also displays the PPP forward and reverse link messages (LCP, IPCP, PAP, CHAP protocols) differentiated in terms of colors.

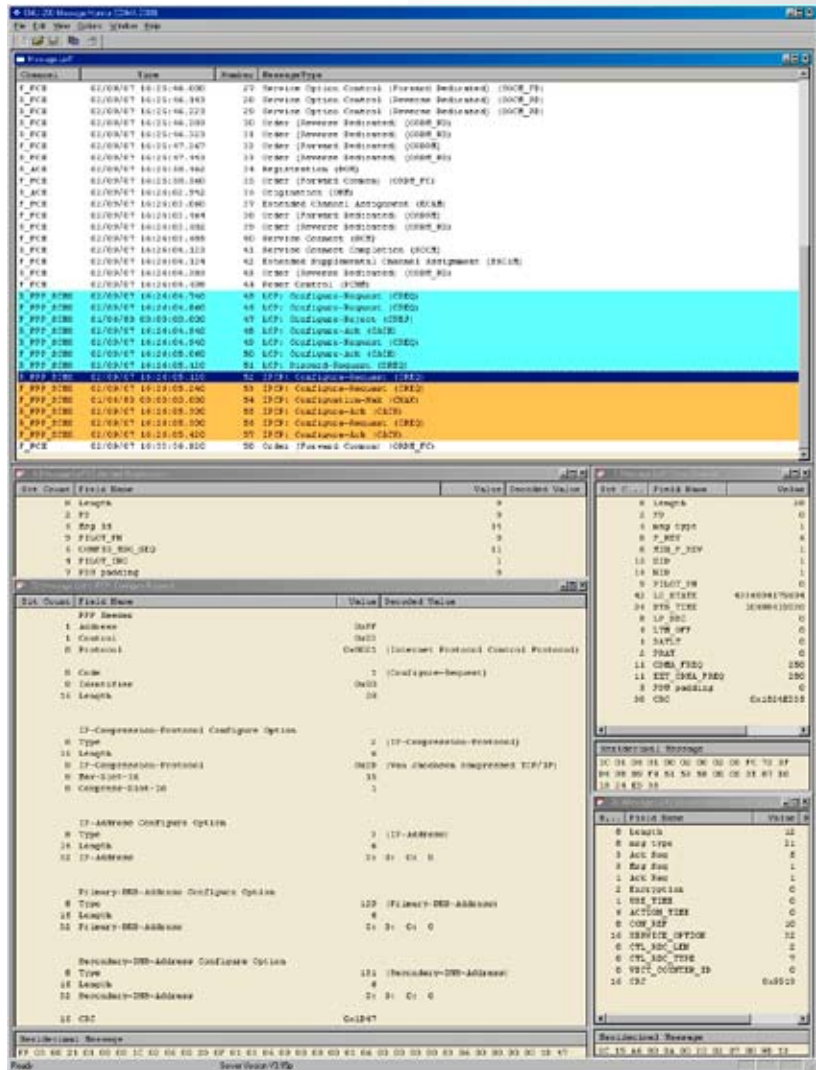

Typical test setup for mobile IP link with mobile station and reference to home agent and foreign agent.

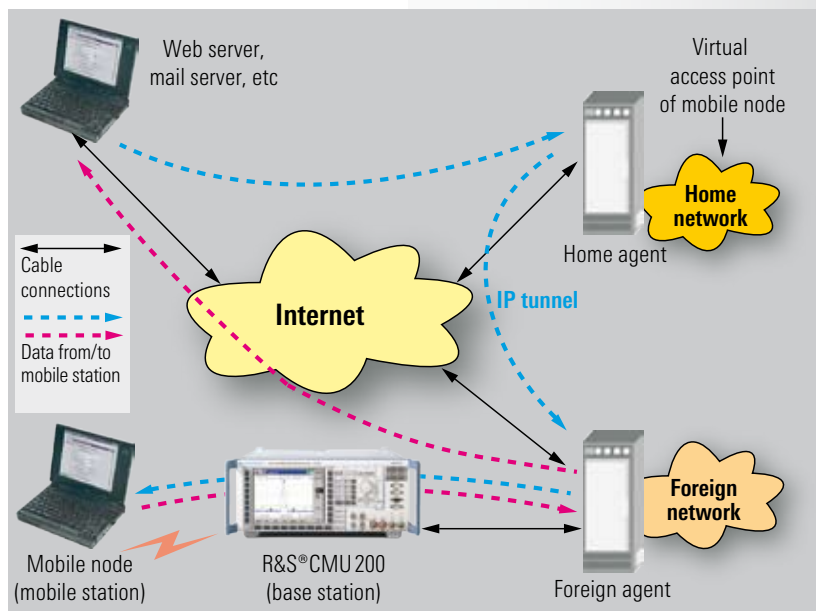

CDMA2000® 1xRTT in the R&S®CMU200

- ◆ Code domain power
 - Code domain power
 - Code domain error power
 - Channel power
 - Reverse pilot channel to code channel time/phase tolerance
- ◆ Spectrum
 - Adjacent channel power (ACP) measurements at four different user-definable frequencies in a ± 2 MHz range
- ◆ Receiver quality measurements
 - Frame error ratio (FER) on FCH, SCHO
 - Dynamic range, sensitivity, and other user-selectable test environments
 - Forward power control measurement
- ◆ Handoffs
 - Implicit handoffs (RF channel, Walsh code, PN offset, frame offset)
 - Inter-band handoff
 - Handoff to AMPS

Non-signaling mode

The module test – without complete call setup – allows process verification and calibration of the DUT's receiver and transmitter. For this purpose, measurements in non-signaling mode are performed.

In the non-signaling mode the R&S®CMU200 provides CDMA-specific measurements and incorporates a signal generator that delivers CDMA-specific signals with pilot, sync, paging, and traffic channels. All major parameters can be configured, e.g. the relative levels of the individual code channels or the power control bits. In addition, the long code mask can be controlled and the sync channel content adjusted. The transmitter and receiver of the R&S®CMU200 can be set independently of each other

and of the frequency bands, which allows analysis of intermediate frequencies, for example.

The range of functions is as follows:

- ◆ Power measurements
 - High-speed narrowband power
- ◆ Modulation (both RC1/2 and RC3/4)
 - Error vector magnitude (EVM), magnitude error, phase error, waveform quality, carrier feed-through, frequency error
- ◆ I/Q analyzer
 - Eye diagram, constellation/vector diagram
- ◆ Code domain power
 - Code domain power
 - Code domain error power
 - Channel power
 - Reverse pilot channel to code channel time/phase tolerance
- ◆ Spectrum
 - Adjacent channel power (ACP) measurements at four different user-definable frequencies in a ± 2 MHz range
- ◆ Power versus frame
- ◆ R&S®Smart Alignment

CDMA2000 1x development

The well-structured, user-friendly menu design and the clear-cut screen layout provide quick access to all features and ensure trouble-free monitoring of the device under test (DUT).

Using the R&S®AMU200A baseband fading simulator and the R&S®CMU200 with optional I/Q IF interface, fading conditions may be simulated and the results evaluated with the R&S®CMU200. In contrast to RF fading, a baseband fading system makes it possible to maintain the high accuracy of the CDMA2000 1x signal in the forward link provided by the R&S®CMU200. Furthermore, baseband-

faded testing usually comes at a much lower cost than an RF fading solution.

In addition to testing various RF parameters, the R&S®CMU200 allows the verification of the acoustic quality of a CDMA2000 1x phone. The decisive factor for the acoustic quality of a mobile phone is the audio signal. For quality verification purposes, a speech coder is required in the radiocommunication tester. The analog signals from the mobile phone's microphone are converted into digital signals, which are transmitted after channel coding. A speech decoder is then needed to convert this digital data received by the radiocommunication tester into audio signals. The R&S®CMU200 also supports, simultaneously, the conversion of audio signals input via the front panel (or internal audio generators) into the compressed digital data that are required to test the speaker in the mobile station.

The R&S®CMU200 currently supports the 8k speech coder (TIA/EIA-96-B), the 8k enhanced speech coder (TIA/EIA-127, enhanced variable rate codec EVRC), i.e. service options 1 and 3, as well as the 13k speech coder (TIA/EIA-733), i.e. service option 17, and the EVRC-B speech coder service option 68. In combination with an external audio analyzer such as the R&S®UPV, high-precision acoustic measurements on CDMA2000 1x mobile phones can be performed, e.g. in line with the TIA/EIA-1042 standard.

For analysis of the signaling messages between the mobile and the R&S®CMU200, an optional message monitor is available. This is an extremely helpful tool for analyzing and verifying the correct implementation of the protocol stack. For SO 33 connections, it also displays the PPP forward and reverse link messages (LCP, IPCP, PAP, CHAP protocols).

Code domain power is a highly important measurement for mobile phones in CDMA2000 1x. Since several code channels are transmitted simultaneously in the reverse link, it must be checked whether the power distribution of the different channels complies with the test specification (TIA/EIA-IS-98-F).

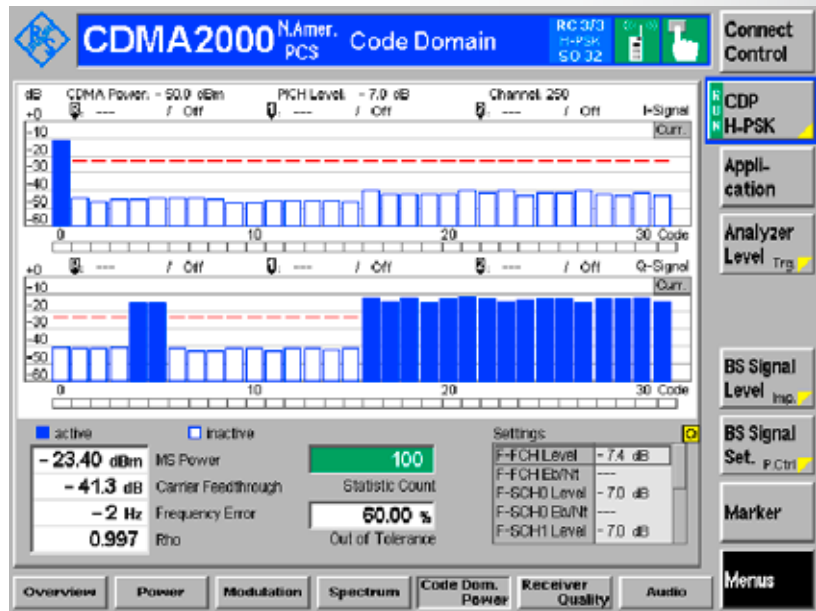

The channel power measurement displays the energy transmitted by the physical channels in the reverse link, separated into I and Q signals.

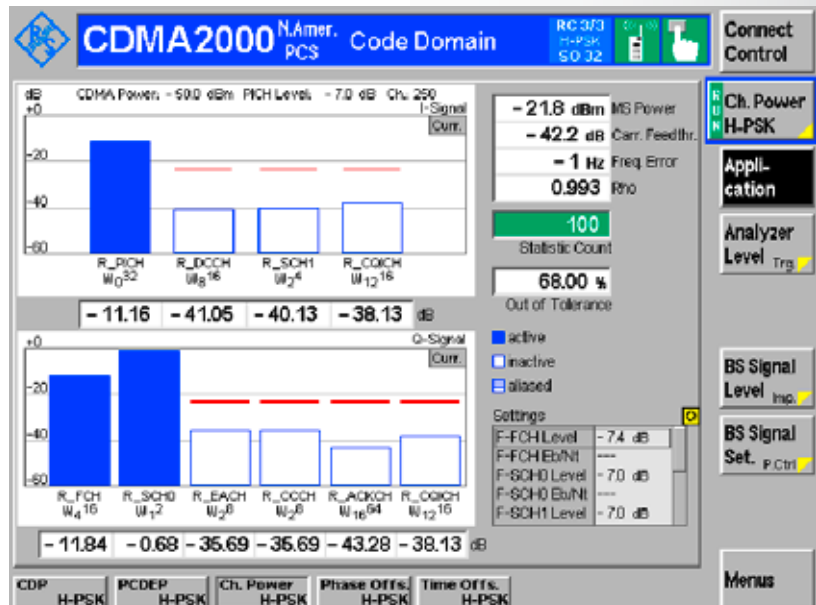

Within a TDSO (SO 32) connection, the frame error ratio (FER) on the fundamental channel (FCH) as well as on the supplemental channel (SCH0) can be evaluated.

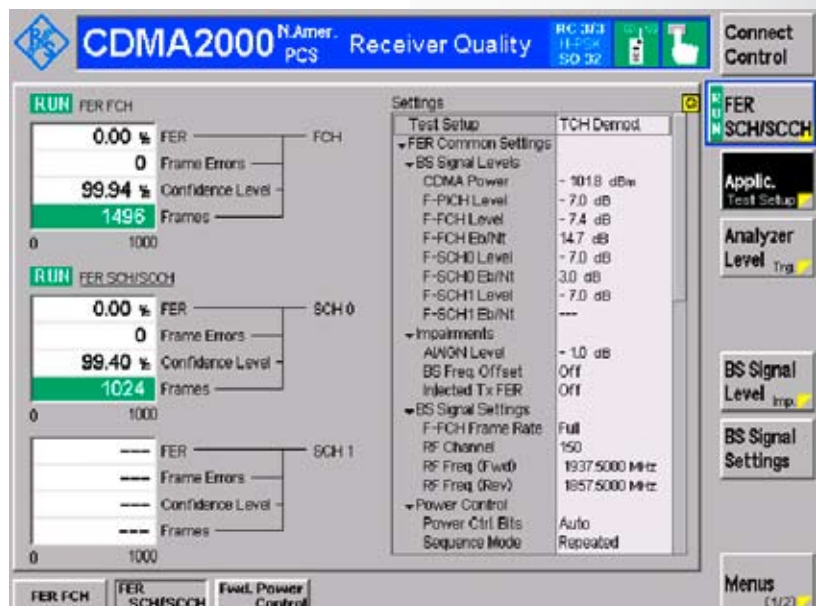

CDMA2000® 1xRTT in the R&S®CMU200

In 3G networks, data links based on the Internet protocol (IP) play a more and more significant role. This calls for new test procedures designed to verify the functionality of IP-based links.

Numerous test scenarios are conceivable, including data rate measurements under ideal RF conditions, as well as with fading or during handoff, and various application tests (e.g. access to mail servers, web meetings, etc). In the past, such tests required access to a real network. Now, these tests can be performed without a network by using the R&S®CMU200, which offers a wide range of configuration options for data connections (based on service option 33).

The R&S®CMU200 allows different test setups to be implemented for different application scenarios. In the simplest case, the R&S®CMU200 can be operated in standalone mode (including mobile IP) to perform data rate measurements on the mobile phone under test. For this purpose, the tester incorporates an internal FTP server that allows test files to be exchanged.

By using a more complex test setup including an external home agent and foreign agent, mobile IP links to points such as a web server or a mail server can be set up, enabling to test complex applications.

Using a setup of two R&S®CMU200, it is possible to verify hybrid mode scenarios of a mobile phone in a combined CDMA2000 1x and 1xEV-DO environment.

Production of mobile phones

The production of mobile phones requires time-efficient and cost-effective measures that simultaneously ensure both high throughput and high yield. Owing to market-leading accuracy and to the unique IEC/IEEE bus concept of the R&S®CMU200, these two goals can be easily achieved in production environments. The R&S®CMU200 provides optimized high-speed measurements for the calibration of the transmitter and the receiver of a mobile phone.

- ◆ Power versus frame is a realtime measurement that was primarily designed for fast and accurate evaluation of defined power steps of a transmitter over a wide dynamic range.
- ◆ R&S®Smart Alignment (R&S®CMU-K47 option) has been designed for fast mobile transmitter and receiver adjustments (TX and RX calibrations) over a wide range of RF channels and power levels. To enable parallel mobile transmitter and receiver tests, the R&S®CMU200 can simultaneously change its generator and analyzer settings after equal time periods.

Repair applications (manufacturing and service centers)

With its outstanding versatility, the R&S®CMU200 is also a suitable tool for mobile phone troubleshooting. Four configurable RF ports and a built-in RF connector switch matrix (standard unit) are provided to enable flexible signal level ranges and switching.

Switching standards

Fast switching between CDMA2000 1xRTT and 1xEV-DO or any of the other numerous standards supported by the R&S®CMU200 is a standard feature of the instrument and can be achieved by simply pressing a button.

Versatile production test layouts are possible, and true multimode test bays that utilize the flexibility and throughput of the R&S®CMU200 are no longer a concept of the future.

R&S®CMU200 CDMA2000 1x options

The following options are available for CDMA2000 1x:

- ◆ R&S®CMU-B83: CDMA2000 1x signaling unit
- ◆ R&S®CMU-K83: CDMA2000 1x software for the 450 MHz bands
- ◆ R&S®CMU-K84: CDMA2000 1x software for cellular bands
- ◆ R&S®CMU-K85: CDMA2000 1x software for PCS bands
- ◆ R&S®CMU-K86: CDMA2000 1x software for IMT-2000 bands
- ◆ R&S®CMU-K87: CDMA2000 1x packet data application testing software
- ◆ R&S®CMU-K47: R&S®Smart Alignment
- ◆ R&S®CMU-B85: 8k QCELP, 8k EVRC, 13k QCELP, EVRC-B speech coder
- ◆ R&S®CMU-B87: interface for CDMA2000 1x data testing incl. layer 3 message monitor software
- ◆ R&S®CMU-U80: low jitter trigger output connector (for A-GPS applications)

CDMA2000 1xRTT highlights of the R&S®CMU200

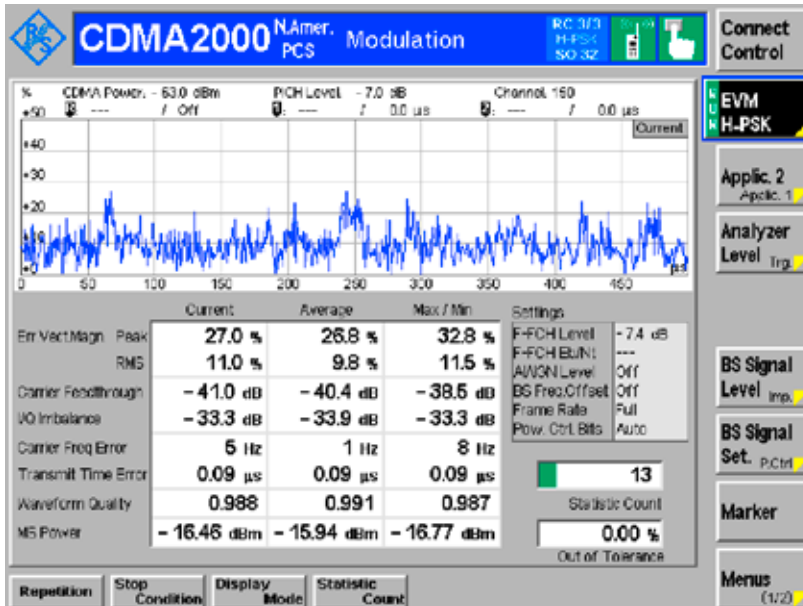

Modulation measurements allow users to check the MS transmitter. Parameters such as EVM, phase error, and frequency error are displayed graphically.

The universal hardware and software concept of the R&S®CMU200 represents the optimum solution for the development and challenges of the CDMA2000 1x standard over the next few years.

- ◆ Support of currently 17 different band classes
- ◆ CDMA2000 1x speech coder for high-precision acoustic measurements
- ◆ Multiple connection types to cover most important test requirements in R&D, production, and high-level service labs
- ◆ Extremely fast measurements
- ◆ Extensive non-signaling for high-speed innovative production test needs
- ◆ Parallel RX/TX measurements ensuring high throughput in production environments
- ◆ Comprehensive signaling mode functionalities
- ◆ Graphical representation of measurement results best suited for R&D labs
- ◆ Various handoffs supported, e.g. hand-off to AMPS, inter-band handoff, between service options and between CDMA2000 1x and IS-95 connection types during an established call
- ◆ Readout and display of many mobile-phone-specific parameters (ESN, slotted timer, station class mark, slot cycle index, user zone identifier, etc)
- ◆ MEID emulation support
- ◆ Quick paging channel and CCI bits can be individually set and enabled or disabled
- ◆ Support of forward closed-loop power control tests as specified in IS-98-F sections 3.4.7, 3.4.8, 3.4.9
- ◆ CDMA2000 1x/1xEV-DO hybrid mode scenarios with two R&S®CMU200
- ◆ Measurements under fading conditions supported (baseband fading; requires the R&S®CMU-B17 option plus a fading generator such as the R&S®AMU200A)
- ◆ Single-box mobile IP emulation
- ◆ IP mobility support
- ◆ Fast switching between wireless applications as a basic functionality without shutdown and reboot

CDMA2000® is a registered trademark of the Telecommunications Industry Association (TIA – USA).

CDMA2000® 1xEV-DO in the R&S® CMU200

CDMA2000 1xEV-DO (TIA/EIA-856-A), officially recognized by the ITU as an IMT-2000 3G standard, is the latest step in CDMA2000 evolution.

CDMA2000 1xEV-DO has been developed in order to make full use of the advantages of an all-IP network; the air interface has been optimized for data transmission.

The 1xEV-DO access terminals being sold are nearly all multimode devices, supporting both the existing CDMA2000 1xRTT standard and the new technology.

Unlike CDMA2000 1xRTT, 1xEV-DO uses a time division multiple access method. The spectral characteristics have not changed with respect to CDMA2000 1xRTT, which enables in-band migration. The protocol stack, however, is completely different from that of CDMA2000 1xRTT.

This makes the upgrade path very attractive for network operators, since the measures necessary to modify the radio access network (RAN) are more or less reduced to exchanging a channel card. Network operators, therefore, are installing hybrid mobile radio networks that support both CDMA2000 1xRTT and CDMA2000 1xEV-DO, which allows them to optimize the capacity for voice connections while at the same time offering modern, profitable data services.

The initial Release 0 standard provides data rates up to 2.4 Mbit/s in the forward link and up to 153.7 kbit/s in the reverse link. Revision A of the standard, now being deployed in numerous networks around the world, provides a maximum data rate of 3.1 Mbit/s in the forward link and 1.8 Mbit/s in the reverse link.

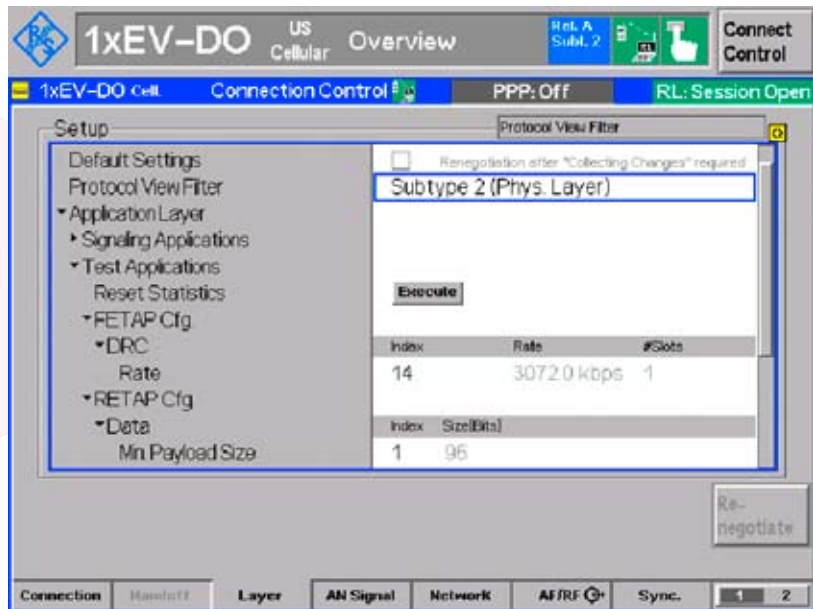

The structure of the 1xEV-DO protocol stack is mapped onto an advanced menu structure for use by R&D and production engineers.

CDMA2000 1xEV-DO Revision A (TIA-856-A) is the first stage in a series of planned upgrades of the 1xEV-DO standard. 1xEV-DO Rev. A introduces enhancements to support quality of service (QoS). These enhancements support latency-sensitive and bandwidth-intensive applications such as enhanced push-to-talk, multiplayer gaming, laptop-based video conferencing, voice over internet protocol (VoIP) and instant multimedia messaging (IMM). These enhancements along with the increased data rates allow operators to provide integrated voice, data and video services.

The faster data rates, particularly on the reverse link, will benefit users who need to send large files such as photos or video over their wireless connection.

The main differences between 1xEV-DO Release 0 and Revision A are the following:

- ◆ Improvements to reverse link (regarding peak data rate and sector throughput)
- ◆ Improved QoS mechanisms
- ◆ Expanded broadcast/multicast applications

CDMA2000 1xEV-DO functionality

The tests provided by the R&S® CMU200 are based on the TIA-866-A minimum performance requirements specification for access terminals (AT).

The R&S® CMU200 simulates a CDMA2000 1xEV-DO base station RF interface, providing the signaling flexibility necessary to test the performance of a mobile phone under the influence of different signaling parameters. These parameters are normally configured by the network operator but can also be set by the R&S® CMU200 for test purposes.

CDMA2000 1xEV-DO signaling measurements

Designed for use with the R&S®CMU200 platform, it ensures accuracy, efficient test, times and repeatability in 1xEV-DO test.

Using forward (enhanced) test application protocol (FETAP/FTAP) and reverse (enhanced) test application protocol (RETAP/RTAP) applications and the R&S®CMU200, the quality of the receiver and the transmitter of a DUT can be tested as defined by the TIA-866-A minimum performance requirements standard.

With an FETAP connection, the quality of a DUT receiver is determined up to a maximum data rate of 3.1 Mbit/s. In this measurement, the DUT returns, via the reverse link, statistics and counts of received packets and erroneous packets that provide information about the connection quality. The 1xEV-DO option of the R&S®CMU200 evaluates the information received in various ways, e.g. by carrying out packet error and performance measurements to determine the actual throughput as a function of the packet size.

With an RETAP connection, the R&S®CMU200 determines the quality of the DUT's transmitter and modulator. This can be done for data rates ranging from 9.6 kbit/s up to max. 1.8 Mbit/s. The DUT can thus be tested not only at a fixed data rate but also over a range of data rates.

Switching standards

Off-the-shelf fast switching between CDMA2000 1xEV-DO, CDMA2000 1xRTT, HSPA, and any of the other standards supported by the R&S®CMU200 – even first-generation cellular technology AMPS – is part of the standard instrument capabilities and may be achieved by simply pressing a button.



The Statistic Overview display of the Receiver Quality application, showing the DUT's received packet errors during a RETAP connection. The achieved throughput (net rate) is calculated and displayed as Forward Link Performance.

Due to its user-friendly menu concept, the R&S®CMU200 provides quick access to all required measurements and optimizes the handling and thus the efficiency of complex measurement tests with appropriate status messages and built-in statistic functions.

The 1xEV-DO option provides extensive testing capabilities both in test mode and in a real-world emulation. Specifically, the R&S®CMU200 supports FTAP/FETAP as well as RTAP/RETAP and also provides end-to-end data testing functionality in a single-box solution. The support of the default packet application (DPA) allows the R&S®CMU200 to be operated as a host for an IP connection. If the R&S®CMU-B87 option is installed, the end-to-end data capabilities are greatly enhanced by allowing a connection to an external network and its servers. Mobile IP support and IP throughput statistics are provided by the R&S®CMU-B87 option.

The 1xEV-DO option supports the full range of data rates and packet sizes available with CDMA2000 1xEV-DO Rev.A, i.e. forward link rates up to 3.1 Mbit/s, reverse link rates up to 1.8 Mbit/s. FETAP/RETAP testing as well as data testing is supported at all rates.

In addition to FTAP/FETAP and RTAP/RETAP, the R&S®CMU200 provides true dynamic network performance using default packet application support for real-world throughput analysis and network emulation.

In conjunction with a baseband fading simulator from Rohde & Schwarz, more accurate and cost-effective solutions can be implemented than by using an RF fader.

CDMA2000® 1xEV-DO in the R&S® CMU200

Versatile production test layouts are possible, and true multimode test bays that utilize the flexibility and throughput of the R&S® CMU200 are no longer a concept of the future.

The range of functions is as follows:

Transmitter measurements

- ◆ Narrowband power
- ◆ Modulation
 - Error vector magnitude (EVM), magnitude error, phase error, waveform quality, carrier feed-through, frequency error
- ◆ I/Q analyzer
 - Eye diagram, constellation/vector diagram
- ◆ Code domain power
 - Code domain power
 - Code domain error power
 - Channel power
- ◆ Adjacent channel power (ACP) measurements at four different user-definable frequencies in a ± 2 MHz range

Receiver measurements based on test connections (FTAP/FETAP, RTAP/RETAP)

- ◆ Receiver quality
- ◆ AT statistics
 - Statistical overview at a glance
 - Control channel PER in connected mode
- ◆ Forward/reverse link quality
- ◆ Forward/reverse link performance

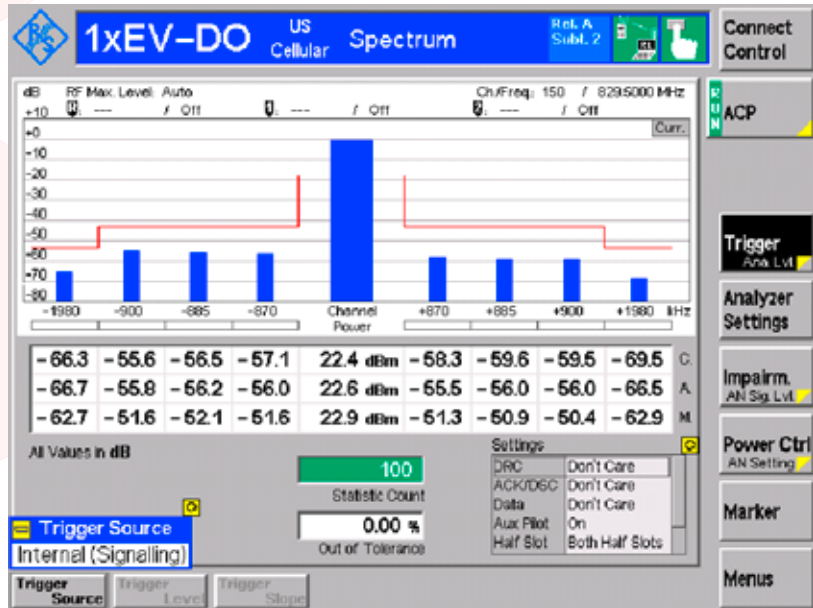

The spectrum measurement provides comprehensive adjacent channel power (ACP) measurements at four different user-definable frequencies in a ± 2 MHz range.

CDMA2000 1xEV-DO non-signaling test concept

Recent production measurement trends have been moving away from “call established” based or “signaling” based testing toward a “module” or “non-signaling” strategy. The main advantage of this approach is reduced test time in comparison to full signaling tests. It is possible to implement vendor-specific tests/procedures and easier to add new test scenarios as the device under test (DUT) matures. In addition, lack of symmetry between forward and reverse data rates in CDMA2000 1xEV-DO makes traditional loopback testing less effective.

With its optional 1xEV-DO capability, the R&S® CMU200 offers a very flexible, all-in-one solution including a 1xEV-DO generator for receiver testing as well as an extensive list of transmitter measurements for testing CDMA2000 1xEV-DO access terminals. The test concept is based on direct control of the DUT with-

out complete signaling by the same computer that controls the R&S® CMU200. The DUT’s non-signaling mode is implemented via the serial diagnostic monitor interface which is already present in most 1xEV-DO terminal designs. The non-signaling mode minimizes test configuration and transition time between tests. Enhanced measurement times and optimized test sequences are a special benefit especially in production environments, yielding higher throughput.

The option R&S® CMU-K47 (R&S® Smart Alignment) allows the DUT’s transmitter and receiver to be calibrated at once over the entire frequency and level range.

Test setup: A test system using a non-signaling test mode is virtually identical to most protocol-based production test setups. It consists of a test controller, a radiocommunications tester with 1xEV-DO option, and the actual device under test. The primary difference is that the device under test operates in the non-signaling mode while the test sequence is being performed.

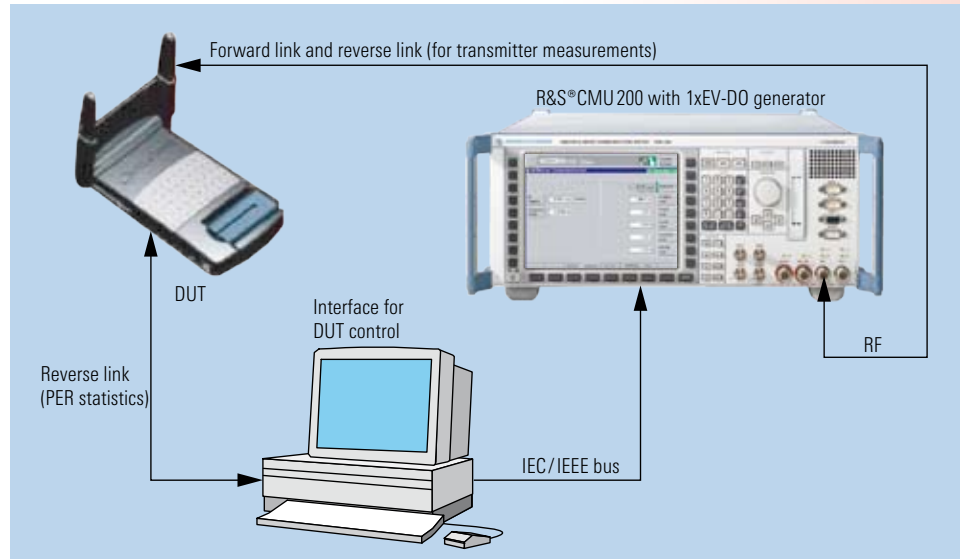

Channel filters: Three different channel filters allow the reverse link signal to be analyzed in eight different signaling states. Users may select whether or not to measure the signal at the time when ACK, DATA, or DRC channel is transmitted (ON or OFF). All modulation measurements as well as the code domain power measurement support the channel filters.

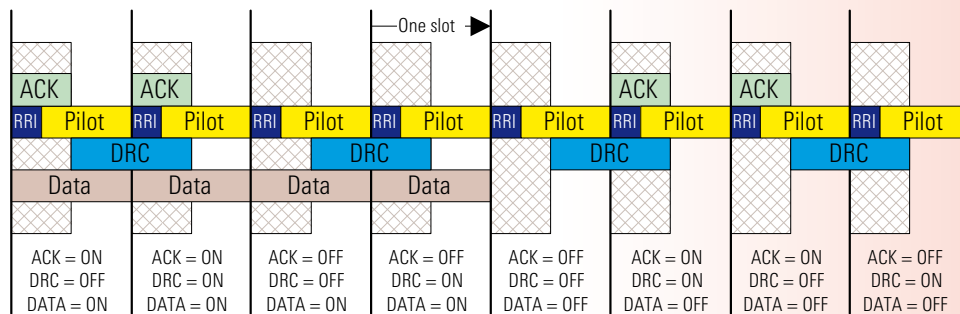

Notes: DRCLength = 2
DRCGating = ON
Measurement window

CDMA2000® 1xEV-DO in the R&S® CMU200

The CDMA2000 1xEV-DO generator offers a high degree of flexibility. This permits considerable flexibility in the configuration of tests for the DUT. Both 1xEV-DO options for the R&S® CMU200 support a wide variety of test configurations, and can configure the following

- ◆ MACIndex
- ◆ Data rate
- ◆ Data pattern
- ◆ DRCLock mode
- ◆ Reverse power control mode
- ◆ Power level
- ◆ PN offset
- ◆ AWGN and frequency offsets

The CDMA2000 1xEV-DO generator (R&S® CMU-B88 option) affords an even higher level of configurability. It is possible to generate traffic for up to 4 DUTs, to change the scheduling system, and control the number of other users in the MAC burst. The R&S® CMU-B88 option of course supports 1xEV-DO Revision 0 and A signal generation. This option also provides more extensive triggering capabilities.

CDMA2000 1xEV-DO non-signaling measurements

The R&S® CMU200 provides a complete set of extremely fast transmitter measurements. Most of the measurements are presented in graphical form which makes the test solution ideal for R&D. A number of measurements can be configured to look at only certain combinations of reverse link code channels. This allows in-depth analysis of transmitter performance in various mobile operating modes.

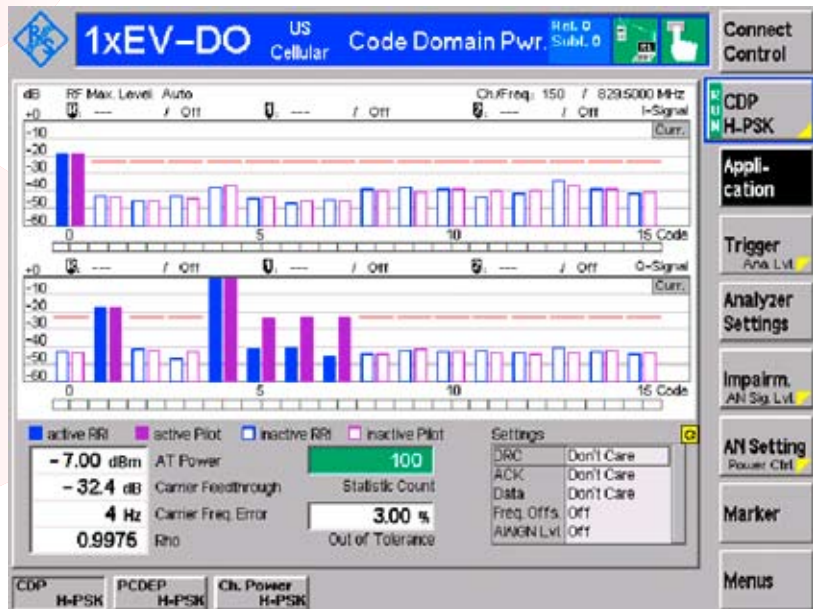

Code domain power measurement (Rel. 0): The code domain power (CDP) includes the time-switching component between RRI and pilot channel. The "blue" bar displays the CDP for the time the RRI channel is up. The "purple" bar shows the CDP value for the time the pilot channel is up.

The list below shows the CDMA2000 1xEV-DO measurements:

Power measurements

- ◆ General power measurement (e.g. for fast power phasing)

Code domain power

- ◆ Code domain power
- ◆ Code domain error power
- ◆ Channel power

Modulation measurements

- ◆ Error vector magnitude (EVM)
- ◆ Magnitude error
- ◆ Phase error

I/Q analyzer

- ◆ Eye diagram, constellation/vector diagram

Spectrum measurements

- ◆ Adjacent channel power (ACP) measurements at four different user-definable frequencies in a ± 2 MHz range

Receiver measurements

- ◆ Via DUT control interface in test

Code domain power measurement (Rev. A):
The application shows the currently used code space during an RETAP connection with DRC index 10.

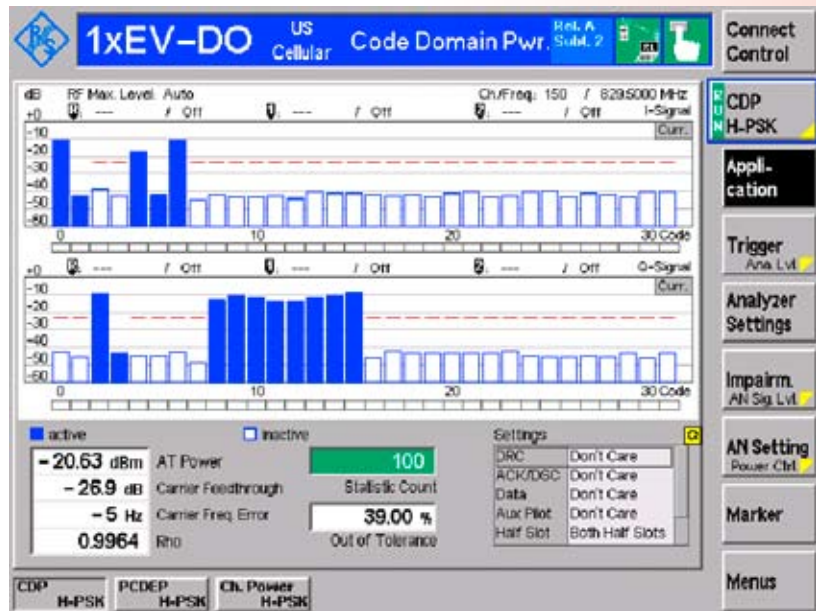

Code domain power measurement (Rev. A):
The channel power application displays the code channels used with their relative energy, and also shows the Walsh cover used for the data channel, in this screenshot Q402.

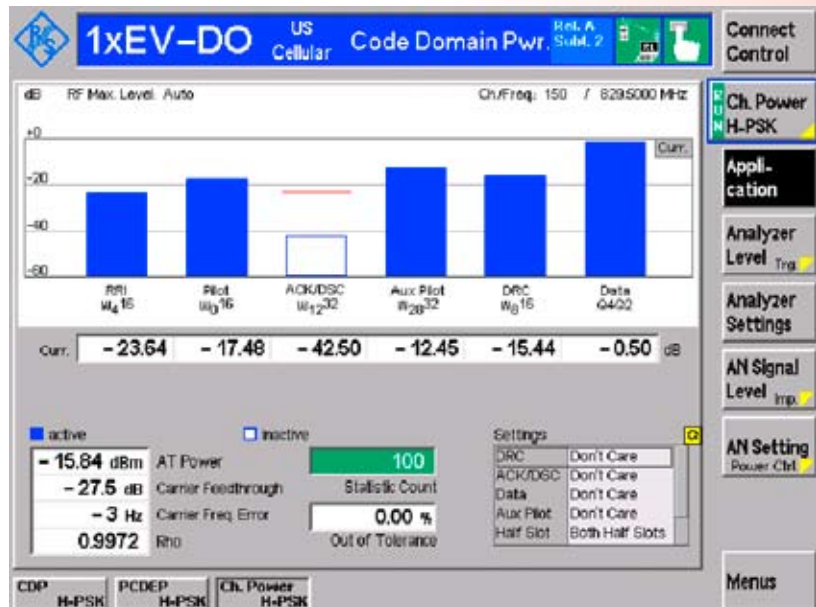

I/Q analyzer: The constellation diagram displays the I/Q position of the sample points in a Y/X grid. This allows signal quality and modulation complexity to be graphically observed at a glance. This picture was taken during an RETAP connection with DRC index 10.

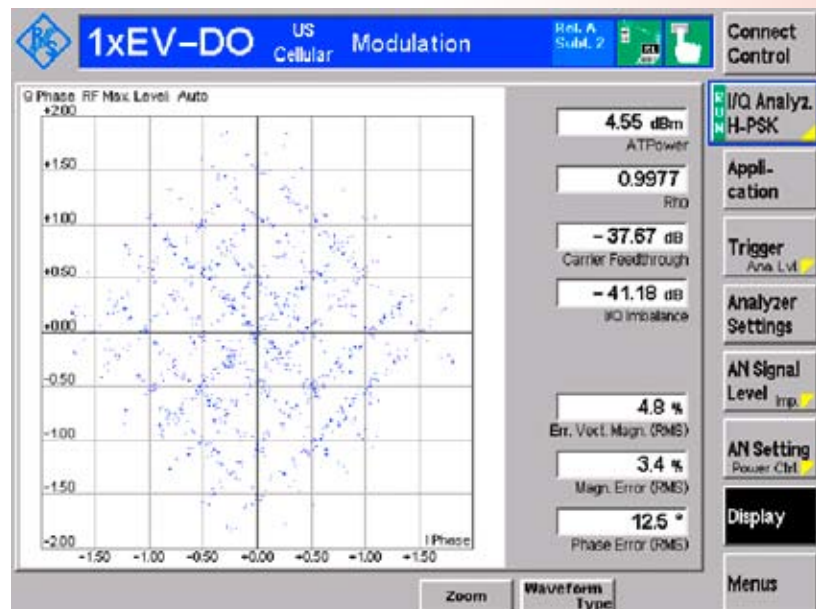

CDMA2000® 1xEV-DO in the R&S® CMU200

CDMA2000 1xEV-DO options

The 1xEV-DO option of the R&S® CMU200 is based on the R&S® CMU-B83 CDMA2000 1x signaling unit. Due to the flexible R&S® CMU200 platform concept, measurement capabilities for various applications can be configured for both signaling and non-signaling.

The R&S® CMU-B89 1xEV-DO signaling module provides the necessary hardware for CDMA2000 1xEV-DO Revision A, CDMA2000 1xEV-DO Release 0, as well as non-signaling-based testing.

To enhance the R&S® CMU200 with 1xEV-DO signaling functionality, the following options are available:

- ◆ R&S® CMU-B83 model 22: CDMA2000 1x signaling unit
- ◆ R&S® CMU-B89: CDMA2000 1xEV-DO signaling module
- ◆ R&S® CMU-K839: CDMA2000 1xEV-DO software for the 450 MHz bands
- ◆ R&S® CMU-K849: CDMA2000 1xEV-DO software for cellular bands
- ◆ R&S® CMU-K859: CDMA2000 1xEV-DO software for PCS bands
- ◆ R&S® CMU-K869: CDMA2000 1xEV-DO software for IMT-2000 bands
- ◆ R&S® CMU-K47: R&S® Smart Alignment
- ◆ R&S® CMU-B87: interface for CDMA2000 1xEV-DO data application testing
- ◆ R&S® CMU-K87: CDMA2000 1xEV-DO data application testing software
- ◆ R&S® CMU-U80: low jitter trigger output connector (for A-GPS applications)
- ◆ R&S® CMU-Z89: hybrid mode test kit

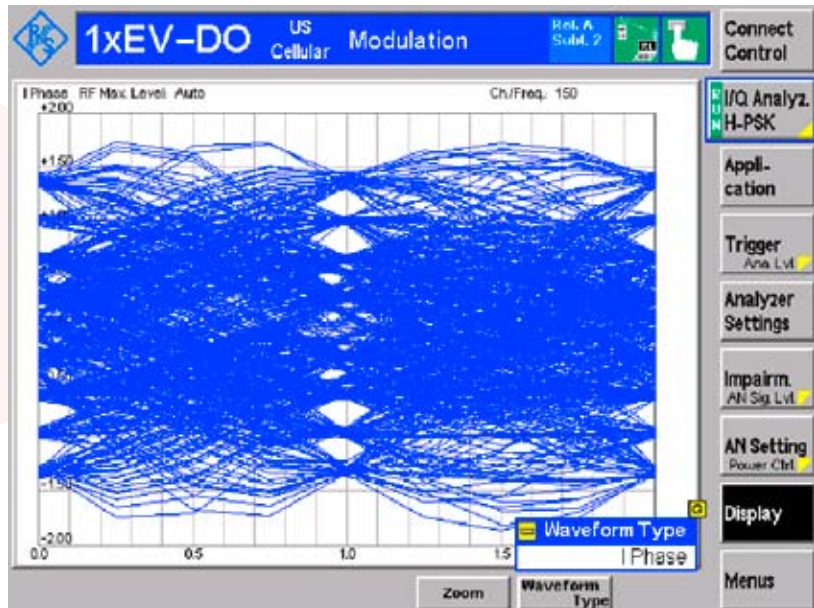

I/Q analyzer: The eye diagram shows the decision path for the demodulation of the signal. This application makes it possible to view the I or Q parts alone, or both at once.

The 1xEV-DO signaling functionality is also available with the R&S® CMU200V10, the signaling tester for the service market.

To enhance the R&S® CMU200 with 1xEV-DO non-signaling functionality without signaling capability, the following options are available:

- ◆ R&S CMU-B83 model 12: CDMA2000 1x signaling unit
- ◆ R&S CMU-B88: CDMA2000 1xEV-DO generator
- ◆ R&S® CMU-K47: R&S® Smart Alignment
- ◆ R&S CMU-K88: CDMA2000 1xEV-DO test software
- ◆ R&S® CMU-U80: low jitter trigger output connector (for A-GPS applications)

The 1xEV-DO non signaling functionality is also available with the R&S® CMU200V30, the non-signaling tester for board alignment and high-volume manufacturing.

CDMA2000® is a registered trademark of the Telecommunications Industry Association (TIA – USA).

CDMA2000 1xEV-DO highlights of the R&S®CMU200



The receiver quality measurement display shows the key results regarding the mobile's receiver performance.

This 1xEV-DO test solution is based on the R&S®CMU200 high-performance radio communication tester; it provides the additional benefits of extremely fast measurement speed, ease of programming, accuracy, reliability, and worldwide service and support. These features help shorten the test development time, increase throughput, and minimize support costs. The first class support is not limited to production demands, but makes the R&S®CMU200 also ideal for use in R&D environments.

Signaling and non-signaling

- ◆ Support of currently 17 different band classes
- ◆ Graphical representation of measurement results best suited for R&D labs
- ◆ Innovative measurements of code domain power, code domain peak error power, channel power
- ◆ Channel filters allow the reverse link signal to be evaluated in eight different states
- ◆ Spectrum measurements at four discrete frequency offsets (user-configurable)
- ◆ Measurements under fading conditions (baseband fading)

Signaling

- ◆ Comprehensive signaling mode functionalities
- ◆ Support of FTAP/FETAP and RTAP/RETAP test application protocol call processing
 - Control channel PER
 - Forward/reverse link PER
 - Reverse link quality
 - Forward/reverse link performance
- ◆ Readout and display of many mobile-phone-specific parameters (ESN, MEID, slot cycle index, etc)
- ◆ Single-box mobile IP emulation
- ◆ IP mobility support
- ◆ Provides enhanced data throughput analysis with peak data rates up to 3.1 Mbit/s
 - Data channel connectivity tests high-speed packet data connection to a real IP network
 - IP throughput monitor allows analysis of data throughput using controlled data impairments
- ◆ Combines CDMA2000 1xRTT with CDMA2000 1xEV-DO test applications in one box for dual-mode CDMA2000 1xRTT/1xEV-DO testing
- ◆ Hybrid mode testing possible using multiple R&S®CMU200 instruments
- ◆ RF channel and band class handoffs

Non-signaling

- ◆ Simultaneous testing of up to four access terminals in non-signaling mode
- ◆ Reduced test times in comparison to full signaling tests
- ◆ Extensive non-signaling for high-speed innovative production test needs
 - Power versus frame
 - R&S®Smart Alignment
- ◆ Extremely flexible 1xEV-DO Revision 0 and A generator allows vendor-specific tests and new test scenarios, also for R&D

Bluetooth® measurements in the R&S® CMU200

General

The R&S® CMU200 was the first Bluetooth® test set on the market. It is the only radiocommunications tester worldwide to offer Bluetooth® as well as all important mobile radio standards in a single instrument.

Applications

The R&S® CMU200 with the Bluetooth® option is the ideal instrument for the production, development and maintenance of any kind of device with an integrated Bluetooth® interface.

Due to its modular platform concept, the R&S® CMU200 is the ideal solution for all cellular-standard mobile-phone production lines.

Parallel operation for high measurement speed

Due to the high measurement speed and large memory capacity of the R&S® CMU200, transmitter and receiver measurements can be carried out simultaneously. When measurements are performed in frequency hopping mode, a significant test depth is rapidly attained. Only a few seconds are required between call setup, transmitter and receiver measurements and call detach. Fast test cycles ensure a fast return on investment.

Many convenient measurement functions

The R&S® CMU200 offers a large number of statistical monitoring and measurement functions. It is possible, for instance, to define individual tolerances for each measured value and to stop a

measurement sequence after a certain number of measurements or when a tolerance has been exceeded. Besides the common traces for power and modulation versus time, averaged minimum or maximum traces can also be displayed over a user-defined number of packets.

Signaling

Setting up a Bluetooth® connection

The R&S® CMU200 acts as the master of a Bluetooth® piconet, the DUT as a slave. The R&S® CMU200 is able to perform the inquiry procedure for the identification of all Bluetooth® devices within range of the R&S® CMU200. All devices found are listed on the display and one of them can be selected for the paging procedure. The R&S® CMU200 then establishes the connection to the DUT and switches it to test mode operation.

The inquiry procedure can be skipped if the Bluetooth® device address of the DUT is already known. In this case, a shorter setup time for the connection can be achieved. This is important for production tests of Bluetooth® devices to increase the maximum throughput of a production line. In line with the Bluetooth® test mode specification, the DUT has to be locally enabled for test mode operation.

After a Bluetooth® link is established, the R&S® CMU200 sends test control commands to the DUT to switch it to the desired test mode. The R&S® CMU200 is then able to perform a number of transmitter and receiver measurements.

The R&S® CMU200 is also capable of setting up a normal Bluetooth® asynchronous connectionless (ACL) link without activating the test mode. Via this normal link, the power and frequency accuracy of every DUT can be measured, regard-

less of whether the DUT has been locally enabled for the test mode.

If a normal (ACL) link is used, the R&S® CMU200 can switch the DUT to the audio, hold, park and sniff modes.

Audio mode

In the audio mode, the R&S® CMU200 establishes a synchronous connection-oriented (SCO) link to the DUT in addition to the ACL link. The R&S® CMU200's built-in Bluetooth® audio codec supports CVSD as well as A-law and μ -law coding. External audio generators and analyzers can be connected by means of one analog input and output each on the R&S® CMU200 front panel. A much more convenient alternative is the R&S® CMU-B41 audio option. This option, in conjunction with the Bluetooth® audio codec, makes it very easy to carry out basic audio measurements on Bluetooth® DUTs.

Park, hold and sniff modes

The power consumption of a Bluetooth® chipset is considerably reduced in these three modes, making them particularly important in all battery-powered Bluetooth® devices. The R&S® CMU200 can switch the DUT to the park, hold or sniff mode, making it possible to check the reduced power consumption by means of external test equipment.

Signaling information from the DUT

The R&S® CMU200 is able to display a variety of information that is received from the DUT (e.g. device name, version numbers, service class, supported features).

Compliance with existing Bluetooth® standards

The R&S®CMU200 is compliant with the Bluetooth® Core Specifications Version 1.1. The Bluetooth® test mode (Core Spec. Part I:1) is implemented with all commands needed to perform the TX/RX measurements. In addition, the R&S®CMU200 is capable of testing all DUTs that support the new Bluetooth® Core Specifications Version 1.2, since the test mode specified in the new version does not include any changes relevant to the R&S®CMU200.

The Bluetooth® RF Test Specification describes RF test cases for the Bluetooth® qualification process. Although the R&S®CMU200 was not designed for qualification tests, the RF test specification was taken as a guideline for the implementation of the R&S®CMU200's Bluetooth® measurements. All TX measurements are implemented in line with the RF test specification Version 1.2.

In connection with the R&S®CMU200, the R&S®CMUGo application software allows the evaluation of the following Bluetooth® test purposes:

- ◆ TRM/CA/01/C (output power)
- ◆ TRM/CA/03/C (power control)
- ◆ TRM/CA/05/C (TX output spectrum – 20 dB bandwidth)
- ◆ TRM/CA/06/C (TX output spectrum – adjacent channel power)
- ◆ TRM/CA/07/C (modulation characteristics)
- ◆ TRM/CA/08/C (initial carrier frequency tolerance)
- ◆ TRM/CA/09/C (carrier frequency drift)
- ◆ RCV/CA/01/C (sensitivity – single-slot packets)¹⁾
- ◆ RCV/CA/02/C (sensitivity – multislot packets)¹⁾
- ◆ RCV/CA/06/C (maximum input level)

¹⁾ Dirty transmitter with static settings for frequency offset and modulation index.

The Connection Control menu allows the DUT to be inquired and paged. After link setup, the R&S®CMU200 can switch the DUT to one of five submodes.

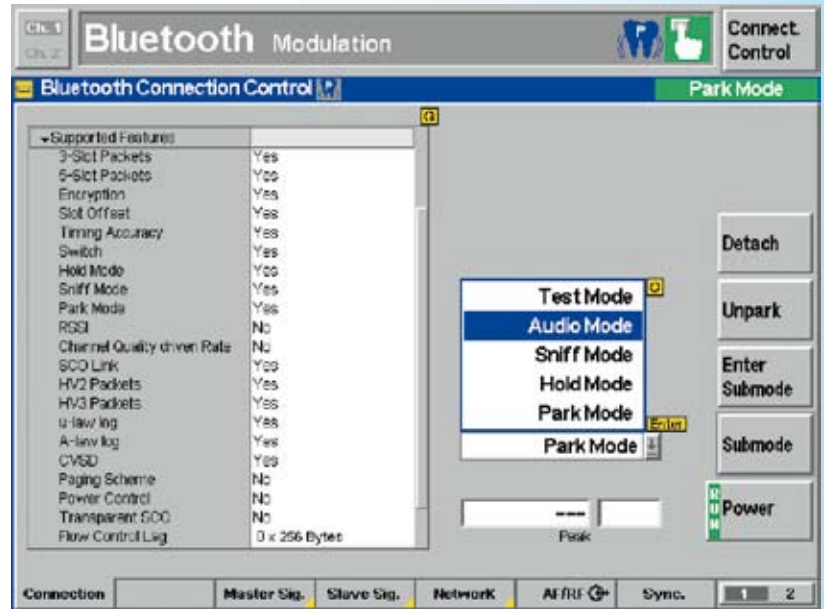

The Power menu shows the results in graphical and scalar form. Statistical functions as well as convenient markers facilitate further evaluation. The DUT power can be varied in stages using the up and down keys.

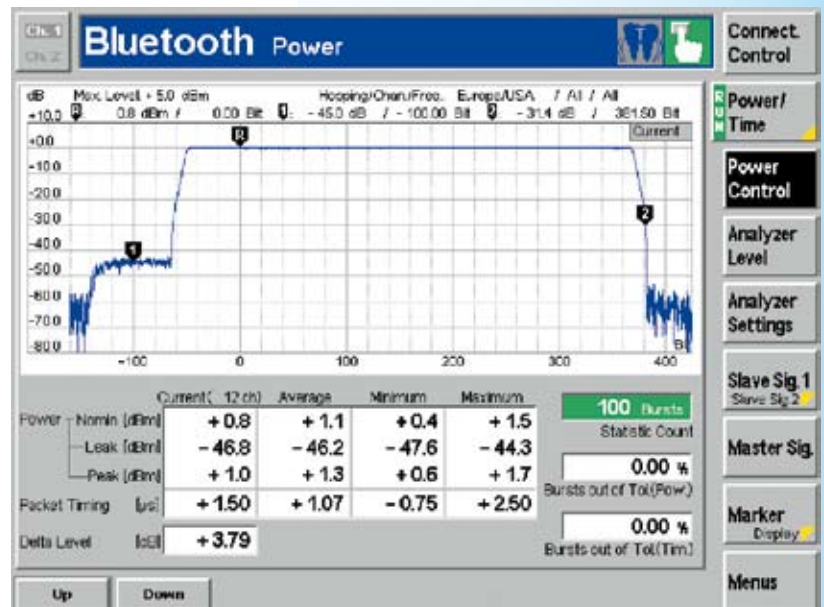

The graphical display of modulation results may be spread between 1/1 and 1/16 of a burst for in-depth analysis. The "Max. Freq. Dev." and "Min. Freq. Dev." results allow the highest and lowest values of a payload to be evaluated individually.

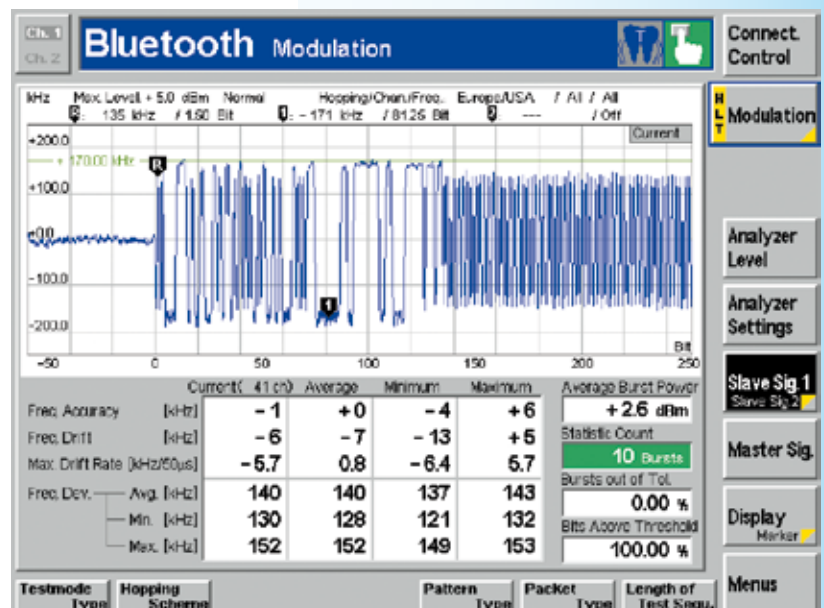

Bluetooth® measurements in the R&S® CMU200

TX measurements

The current measurement values for each parameter are displayed on the R&S® CMU200 screen. Additionally, average, maximum and minimum values are displayed as a result of a statistical evaluation of a definable number of Bluetooth® packets (bursts).

Power measurements (output power)

Measurement parameters:

- ◆ Nominal power (measured as the part of the burst starting at the detected first bit of the preamble (bit 0) to the last bit of the burst)
- ◆ Peak power (shows the highest power level within a burst)
- ◆ Leakage power (measured within defined areas before and after the burst)

Power control

The Power menu enables the power control function of a Bluetooth® DUT to be checked. In this mode, the R&S® CMU200 can send the "Power up" and "Power down" commands to the DUT. The user has two keys for manual power control. After each keystroke, the R&S® CMU200 displays in a measurement window the difference level as compared to each previous power level. In compliance with the Bluetooth® specifications, all difference values must be in the 2 dB to 8 dB range. When the maximum or minimum power level is reached, the DUT sends a message which is displayed on the R&S® CMU200.

Timing measurements (packet timing error)

Measurement parameter:

- ◆ Packet alignment (distance between ideal master receiver slot and detected bit 0 of the received burst)

This measurement is displayed on the Power screen.



The DUT can be connected to the R&S® CMU200 via an RF coupler (antenna) or a cable.

Modulation measurements (modulation characteristics/quality)

Measurement parameters:

- ◆ Frequency accuracy/initial carrier frequency tolerance (ICFT) (difference between measured frequency and intended transmitted frequency, measured in the preamble at the beginning of a packet)
- ◆ Carrier frequency drift (difference between the frequency at the start of the packet and the frequency in the payload)
- ◆ Maximum drift rate (maximum drift rate anywhere within the packet payload)
- ◆ Average, maximum and minimum frequency deviation (calculated over the packet payload)

In compliance with the Bluetooth® RF test specifications, a minimum of 99.9% of all measured bits must have a frequency deviation of at least 115 kHz. The R&S® CMU200 shows the measurement results in an additional window in the modulation display.

Spectrum measurements

20 dB bandwidth (occupied bandwidth)

The detection level for determining the occupied bandwidth is adjustable. It is used as a reference for determining the lowest frequency below the transmit frequency of the DUT (f_L) and the highest frequency above the transmit frequency of the DUT (f_H)

Measurement parameters:

- ◆ Emission peak
- ◆ f_L , f_H and the difference ($f_H - f_L$) for the Current, Average and Maximum display modes

Adjacent channel power (ACP)

The center channel as well as the three higher and the three lower adjacent channels for the measurement are user-configurable.

Measurement parameters:

- ◆ Power of the center channel (for Current display mode)
- ◆ Power of the selected adjacent channels (for Current, Average and Maximum display modes)

The spectrum measurements are particularly important for the continuously growing market share of Bluetooth® power class 1 equipment (+20 dBm). In this power class, instruments with impure RF can significantly impair signals for users of adjacent frequencies.

RX measurements

For RX measurements, the built-in signal generator generates a selectable bit sequence, which is looped back in the DUT and demodulated and processed by the R&S® CMU200 again. The TX level of the R&S® CMU200 can be adjusted for this measurement.

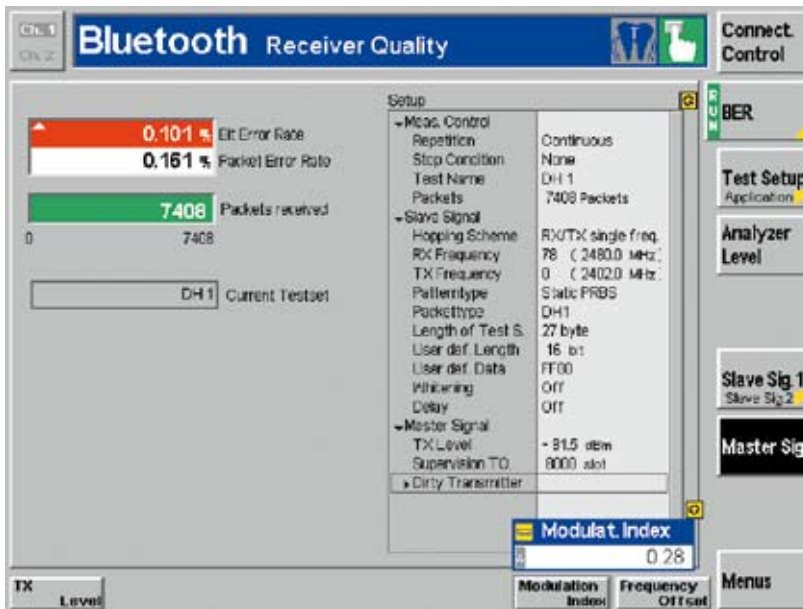

The receiver quality measurement includes the output of BER and PER values. It supports three modes, i.e. single shot, continuous and search of a target BER value, by automatic variation of the R&S®CMU200 output level. The modulation index and the frequency offset of the R&S®CMU200 transmitter signal can be set in any combination ("dirty signal").

Sensitivity (single slot packets/multi-slot packets)

Measurement parameters:

- ◆ BER (percentage of bit errors that have occurred within the current statistical cycle)
- ◆ BER search function (sensitivity level for a predefined BER level)
- ◆ PER (percentage of packet errors that have occurred within the current statistical cycle)

Definable dirty transmitter parameters

The Bluetooth® RF test specifications stipulate a "dirty transmitter" for measuring receiver sensitivity. Its two main parameters, i.e. modulation index and frequency offset, can be continuously adjusted on the R&S®CMU200 and set in any combination. The R&S®CMU200 can use dirty transmitter settings even during link setup (inquiry, connect), thus enabling a wide variety of tests that far exceed test specification requirements.

Control commands to the DUT

The R&S®CMU200 can send control commands with user-specific contents to the DUT via the normal ACL link. This application, which is very useful in production,

allows the control of specific DUT functions via the RF interface, e.g. switching a headset LED on and off.

Channel display in frequency-hopping mode

The R&S®CMU200 enables the convenient determination of all RF channels in which the DUT exceeds specified tolerances. If "on limit failure" is set as a stop condition in frequency-hopping measurements, the R&S®CMU200 automatically stops the measurement when a measured value exceeds the definable limit values.

The R&S®CMU200 in addition displays the number of the channel in which the out-of-tolerance condition occurred – a very helpful function for laboratory measurements.

Measurements without link setup

Many Bluetooth® DUTs can be locally switched to the transmitter test mode via the HCI interface. The R&S®CMU200 can carry out power, frequency and modulation measurements on such DUTs without previously establishing a Bluetooth® link.

Bluetooth® wireless technology highlights of the R&S®CMU200

- ◆ Measurements in Bluetooth® test mode, non-test mode or without a connection
- ◆ Selectable channels and stop conditions for in-depth signal analysis
- ◆ Spectrum measurements (ACP and 20 dB bandwidth)
- ◆ Park, hold and sniff modes for power consumption tests
- ◆ Audio codec integrated (CVSD, A-law, μ -law) for test of audio equipment
- ◆ High measurement accuracy and speed
- ◆ Parallel TX and RX measurement of the RF interface in loopback mode
- ◆ Output of Bluetooth®-specific clock signal
- ◆ IF signal output

Supported standards

- ◆ Bluetooth® Core Specifications Version 1.1 (DUTs in line with 1.2 can also be measured)
- ◆ Bluetooth® Test Specification V1.2, vol. 2, Radio Frequency

The Bluetooth word mark and logos are owned by the Bluetooth SIG, Inc. and any use of such marks by Rohde & Schwarz is under license.

Testing applications in mobile radiocommunications

R&S®CMU200 goes Internet: testing data applications

The highly successful R&S®CMU200 Universal Radio Communication Tester, which was originally designed as a pure RF tester for the various mobile radio standards used around the world, now enables additional user groups to test video telephony and data applications.

Appealing compact solution

Both developing and providing data applications for mobile radio present a multitude of new challenges. Most applications in data communications are based on the Internet protocol (IP), which in turn is based on the client-server principle. This means that a client uses a mobile phone to request services that are provided by a server in the communications network.

The software for these applications is usually developed on PCs; after its implementation and extensive computer simulations, the software is ported to the mobile phone. To perform further tests on the mobile phone itself, a public mobile radio network or the simulation of such a network is required.

Up to now, radio networks could usually be simulated only with the aid of complex setups. This is remedied by the R&S®CMU200, which is a very interesting alternative for such tasks.

Test setup

Application test setups basically consist of a mobile phone, the R&S®CMU200 and a PC. The mobile radio tester, which is connected to the mobile phone via the radio interface, simulates the mobile radio network. Via an Ethernet connection, it accesses the IP-based computer world, which can be either a local area network

(LAN), the Internet or, at its simplest, a controller, where the servers providing the communications services can be accessed. The user usually accesses these services from the mobile phone via mobile originated calls.

The R&S®CMU200 bridges the gap between wired data communications and radiocommunications across various protocol layers.

When the R&S®CMU200 is combined with the Fading Simulator R&S®ABFS, the operation of a mobile telephone under various fading scenarios such as in an automobile at various speeds and reception conditions can be simulated. Thus, the reliability of data exchange can be tested and evaluated.

TCP/IP services

The clients on the mobile phone require suitable servers at the controller end as a counterpart for application tests.

The R&S®CMU-K96 WCDMA application testing option allows IP-based data applications to be tested on a mobile phone; in addition, it includes several TCP/IP servers, for example an HTTP server, which allows you to start a web browser on a mobile phone. Another server is the MMS center (MMSC) with basic functionality, which can be used to test the transmission and reception of multimedia messages on a mobile phone.

Future prospects

Application tests are becoming more and more important in mobile radio. Rohde & Schwarz is meeting this trend by continuously developing new solutions in this field. The licensing authorities have responded to changes in the way mobile communications are used: By developing test scenarios with exact specifications, they define appropriate tests at the application level that will ensure that mobile radio networks will also operate smoothly in the future.

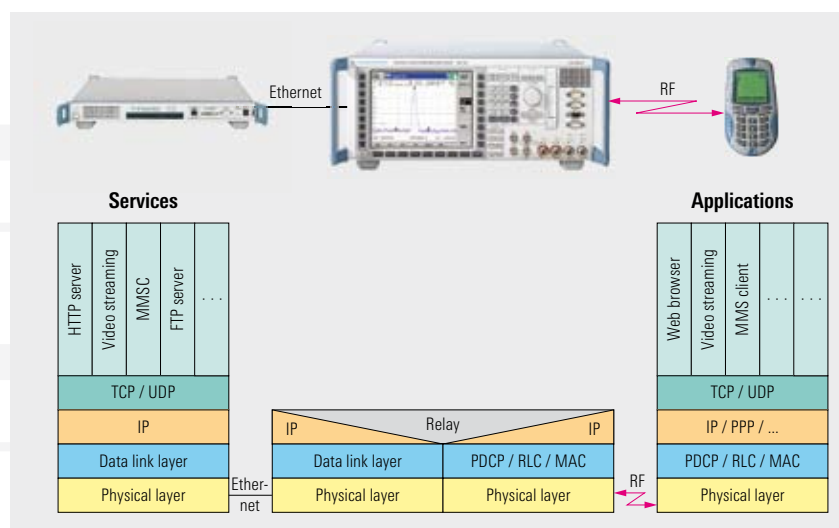

Versatile application tests in (E)GPRS mobile radio

The R&S®CMU-K92 software option allows you to test applications for 2.5G mobile phones. For example, you can now test the transmission or reception of multimedia message services (MMS), Internet browsing or video streaming within a simulated (E)GPRS network environment. In addition to measuring the known RF parameters of power, spectrum or modulation, you can now also perform such tasks as displaying data throughput or analyzing protocols.

(E)GPRS application tests with the R&S®CMU200

Owing to significant protocol stack extensions, the R&S®CMU 200 now also allows you to test applications via GPRS and EGPRS(EDGE) mobile phones simply by activating a new software option.

The new software option makes it possible to test almost any IP-based applications in packet-oriented mode via an IP gateway.

You can simply test proper functioning, but also check whether different applications that are simultaneously activated on a mobile phone run smoothly.

In addition to displaying the current data throughput of the IP packets exchanged between mobile phone and server, the R&S®CMU200 also records various transmission protocols.

Regardless of these activities, it is still possible to measure and analyze the RF signals transmitted by GPRS or EGPRS mobile phones on the R&S®CMU200 with respect to power, spectrum or modulation. Unlike the previous transmitter test, the measurement is now performed as part of the application data transmis-

sion and no longer on the basis of pseudo-random binary sequences (PRBS). If two R&S®CMU200 testers are available, the application tests can be expanded to accommodate data end-to-end tests, for example for checking the exchange of an MMS message between two mobile phones. If only one R&S®CMU200 is available, the transmission and slightly delayed reception of an MMS message with one mobile phone can also be implemented using the loopback setting in the MMSC.

Powerful aid in the development lab

The new R&S®CMU-K92 software option for the R&S®CMU200 for the first time allows application design engineers to test their work in the lab on mobile phones in a simulated radio network. In this case, the main focus is on proving that the application runs smoothly on the mobile phone under normal operating and radio conditions.

Recording of all exchanged IP data packets with time stamp and display of the data transmission rate achieved.

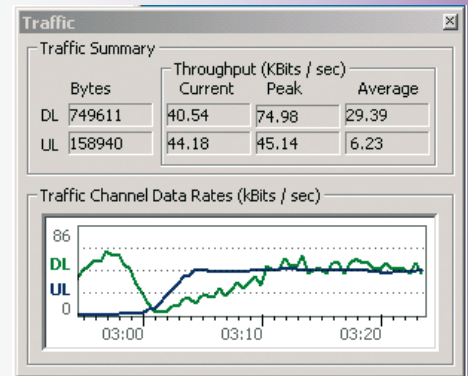
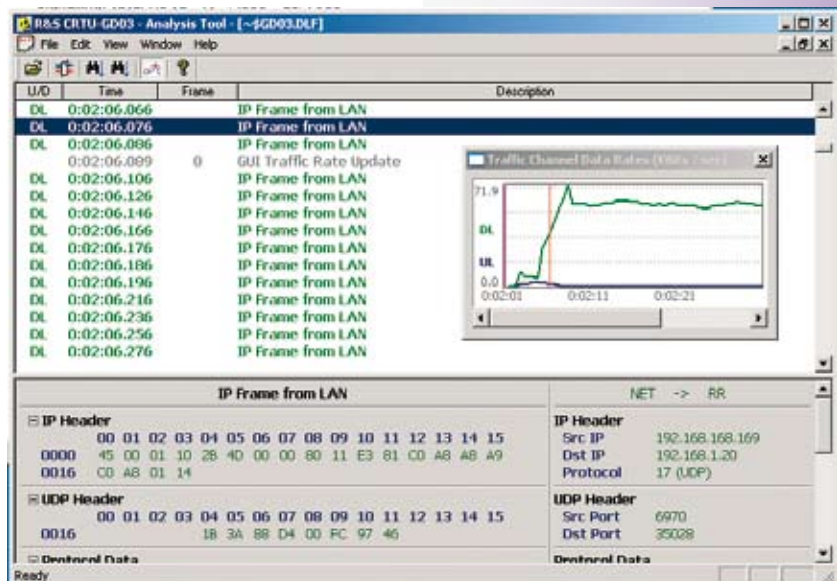

Throughput of IP data exchanged between mobile phone and radio network in uplink (UL) and downlink (DL).

Future prospects

Option R&S®CMU-K92 is the platform for further application tests. It is required in order to run validated MMS test cases or to test complex applications such as push to talk over cellular (PoC). In the forthcoming configurations, data applications can also be tested while voice transmission is in progress. If feasible with the mobile phone, both applications (circuit-switched/packet-switched) can then be operated and tested simultaneously in the dual transfer mode.

Testing applications in mobile radiocommunications

WCDMA: data applications and video telephony test

Option R&S®CMU-K96 makes it possible to test data applications on WCDMA mobile phones.

Settings and measurement results

The configuration of the RF parameters of a WCDMA radio network can be dynamically adjusted on the R&S®CMU200 during application testing.

Changing the channel numbers triggers an intracell handover, for example. Since a reduced transmit level increases the bit error probability at the receiver end, an application function on a mobile phone can also be tested under adverse receive conditions.

If the application test is performed in compressed mode, the mobile phone is subjected to additional stress, which allows you to check the quality of the UE report transmitted from the mobile phone to the tester. While an application is running on the mobile phone, the known transmitter measurements such as power, code domain power, spectrum and modulation can still be performed. The block error ratio (BLER) determined by the R&S®CMU200 is used to evaluate the receiver in the mobile phone.

An inner loop power measurement can be used during the application test, for example, to test the accuracy of a mobile phone's amplifier when traffic power commands (TPC) are being carried out.

Remote control and automation

To remote-control the R&S®CMU200 during application tests, an IEC/IEEE bus interface is available; it can be used, for example, to automatically obtain measurement results and measurement values – a prerequisite for program-controlled sequences. Such automatically running tests can be repeated at any time and as often as necessary without staff intervention, thus helping to increase the system's efficiency.

Protocol analysis

After the software has been ported to the mobile phone, users often want to record protocols to optimize internal processes or to perform an error analysis that may be necessary. The R&S®CMU-Z46 WCDMA message analyzer and recorder option allows all universal terrestrial radio access network

(UTRAN) protocol layers to be recorded, which can then be used for more detailed analysis. This powerful tool permits in-depth analyses, including transport layer analyses.

Video telephony

In all likelihood, video telephony is the most spectacular new WCDMA application. It is unique in that it is circuit-switched, and not IP-based like the previously described applications. The WCDMA firmware checks this functionality without requiring optional extensions. The test is performed in echo mode, where the transmission and reception of video and audio signals can be checked with just one mobile phone. The video telephony signals transmitted by the phone to the R&S®CMU200 are looped back by the radio tester and displayed by the phone as would-be video and audio signals of a called station.

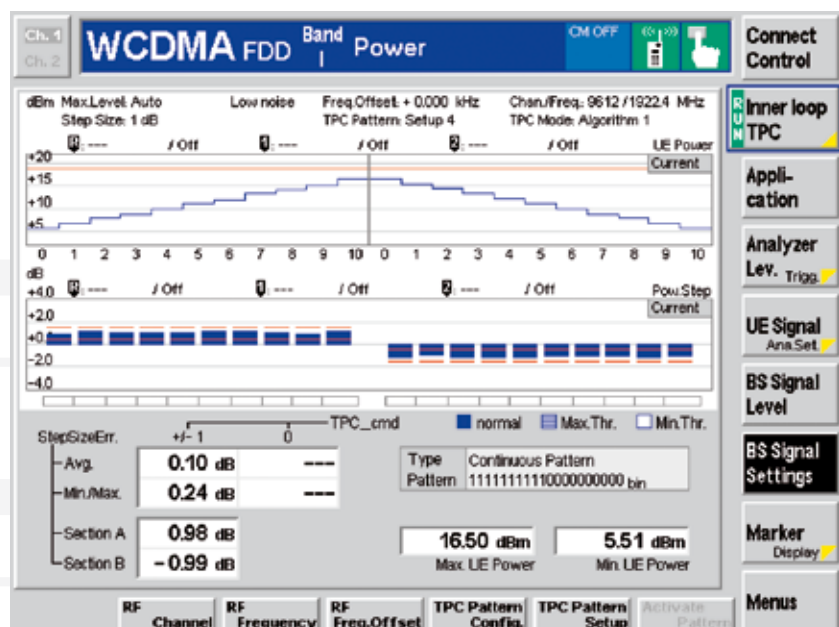

Testing CDMA2000® 1x data applications

Standard CDMA2000 mobile radio networks have already been in commercial use since 2000 in many Asian countries (e.g. Japan and South Korea), the Americas (e.g. the USA and Canada), as well as in Eastern Europe. With the options R&S®CMU-B87 and R&S®CMU-K87 the R&S®CMU200 now offers extensive test capabilities for data applications for this important global 3G standard.

Extensive test capabilities

The CDMA2000 1x mobile radio standard, which was developed by the 3GPP2 standardization body, is officially recognized by the ITU as an IMT-2000 standard for the third mobile radio generation (3G). Most deployments of CDMA2000 1xRTT networks have limited the peak data rate to 153.6 kbit/s. CDMA2000 1xEV-DO Rev. A networks provide a maximum data rate of 3.1 Mbit/s in the forward link and 1.8 Mbit/s in the reverse link.

In these networks, data links based on the Internet protocol are playing a more and more significant role. This calls for new test procedures designed to verify the functionality of IP-based links. For example, the TIA/EIA standard TIA-898 specifies data rate measurements for FTP links.

Service Option 33

In its Service Option 33, the TIA/EIA standard IS-707-A specifies IP-based data links for the CDMA2000 standard. The R&S®CMU200 provides all parameters required for this service option, ranging from traffic channel configuration (data rates of up to 153.6 kbit/s can be set for the supplemental channel (SCH) both for the forward and the reverse link) through to the parameters for mobile IP and authentication.

Rx	Rx Total	Tx	Tx Total	RLP Frame Type
2	217	1	814	Data (Unsegmented)
0	0	0	0	Data (Segmented)
3	655	10	12936	Fill
40	20944	0	0	Idle
1	425	0	0	NAK
0	9	0	0	SYNC
0	9	0	0	ACK
0	0	0	9	SYNACK
7	1852	39	9840	B_Data
0	0	289	58219	C_Data
0	0	7	4674	D_Data
0	0	0	0	Reassembly
0	0	104	126099	Blank
0	0	0	0	Invalid
53	24111	450	212591	Summary

Summary Data:

- Rx: 44523 PPP Total Bytes, 0.8 kBIT/s Data Rate
- Tx: 3753682 PPP Total Bytes, 10.18 kBIT/s Data Rate

Statistical evaluation of data transfer between the R&S®CMU200 and the mobile phone during the application test. After the RLP (radio link protocol type 3) and IP data packets are exchanged, the transmitted and received packets are evaluated using different criteria.

PPP authentication

For setting up a point-to-point protocol (PPP) link, the R&S®CMU200 can be configured to request PPP authentication from the mobile phone. The R&S®CMU200 supports two methods of authentication: CHAP (challenge handshake authentication protocol) and PAP (password authentication protocol).

Mobile IP

Mobile IP is an addition to the conventional Internet protocol. It makes the movements of a mobile computer (mobile node, i.e. in this case a mobile phone) transparent for data applications and the higher protocol layers.

PPP link status

During periods in which the mobile phone is not transmitting or receiving data, it switches to an idle state referred to as dormant mode. In this mode, the PPP link is maintained, but no traffic channel connections are set up in the CDMA2000 network. The R&S®CMU200

indicates the various PPP states the mobile phone can assume.

TX/RX RLP frame and IP packet statistics

A statistical evaluation based on counts of the different parameters makes it possible to track the data flow through the base station, i.e. the R&S®CMU200. The following types of data are counted separately for the TX and RX directions.

Application scenarios

The R&S®CMU200 allows different test setups to be implemented for different application scenarios. In the simplest case, you can operate the tester in the standalone mode to perform data rate measurements on the mobile phone under test.

I/Q and IF interfaces for the R&S®CMU200

Functionality

The R&S®CMU-B17 option allows access to analog I/Q and IF signals in both communication directions (uplink and downlink). Once a radio link has been established, complex I/Q signals can be applied or transmitted for further analysis. This solution will allow the R&S®CMU200 to be used for new tasks in the development and testing of mobile phones and their modules.

Technical concept

The selectable I/Q and IF interface module is looped between the RF module (modulator, demodulator) and the digital module (test DSP, signaling unit) of the R&S®CMU200. During normal operation without access to I/Q or IF signals, the interface module can be set to the bypass mode. This eliminates any further influence on the transmit and receive signal, and the original data of the instrument is retained. In addition to preconfigured default settings for constantly recurring T&M tasks (e.g. fading of the transmit signal), all types of customized signal path combinations can be set.

Receiver tests under fading conditions

A fading simulator is used to test the receiver characteristics of mobile phones under practical conditions. An RF channel that is ideal if the tester and the DUT are connected by means of a cable is provided with fading effects that also occur under real field conditions.

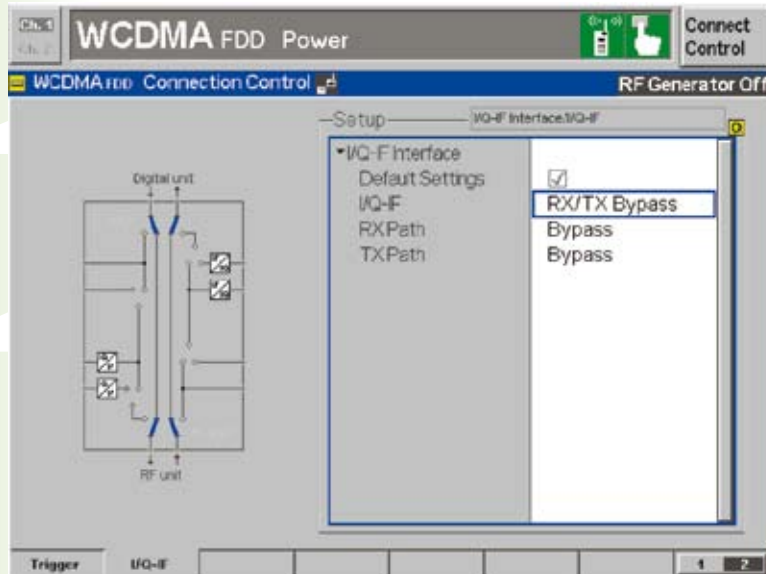

Fitted with the R&S®CMU-B17 option, the R&S®CMU200, together with the Fading Simulator R&S®AMU200A, provides a cost-effective solution for the specified measurement task. Optionally, the Signal Generator R&S®SMU200A with the option R&S®SMU-B14 can be used; the transmit module of the generator can also provide a faded RF signal.

Testing of mobile radio modules

Another major application is the generation and analysis of I/Q signals. Most mobile radio modules include an RF module and a baseband module that communicate with each other via an analog I/Q interface. The I/Q and IF interface can now be used to access the RF modules from both sides.

Quite often, different teams in development departments are responsible for the RF and the baseband modules. Testing via the I/Q interfaces allows space- and time-independent development.

I/Q signal analysis

If I/Q signals are applied to the receive path of the R&S®CMU200, they can be analyzed analogously to the RF signals. In addition to more complex modulation parameters (error vector magnitude (EVM), peak code domain error power), direct I/Q parameters such as I/Q offset or I/Q imbalance can be analyzed.

Your local Rohde & Schwarz representative will gladly provide you with further information about the R&S®CMU-B17 option.

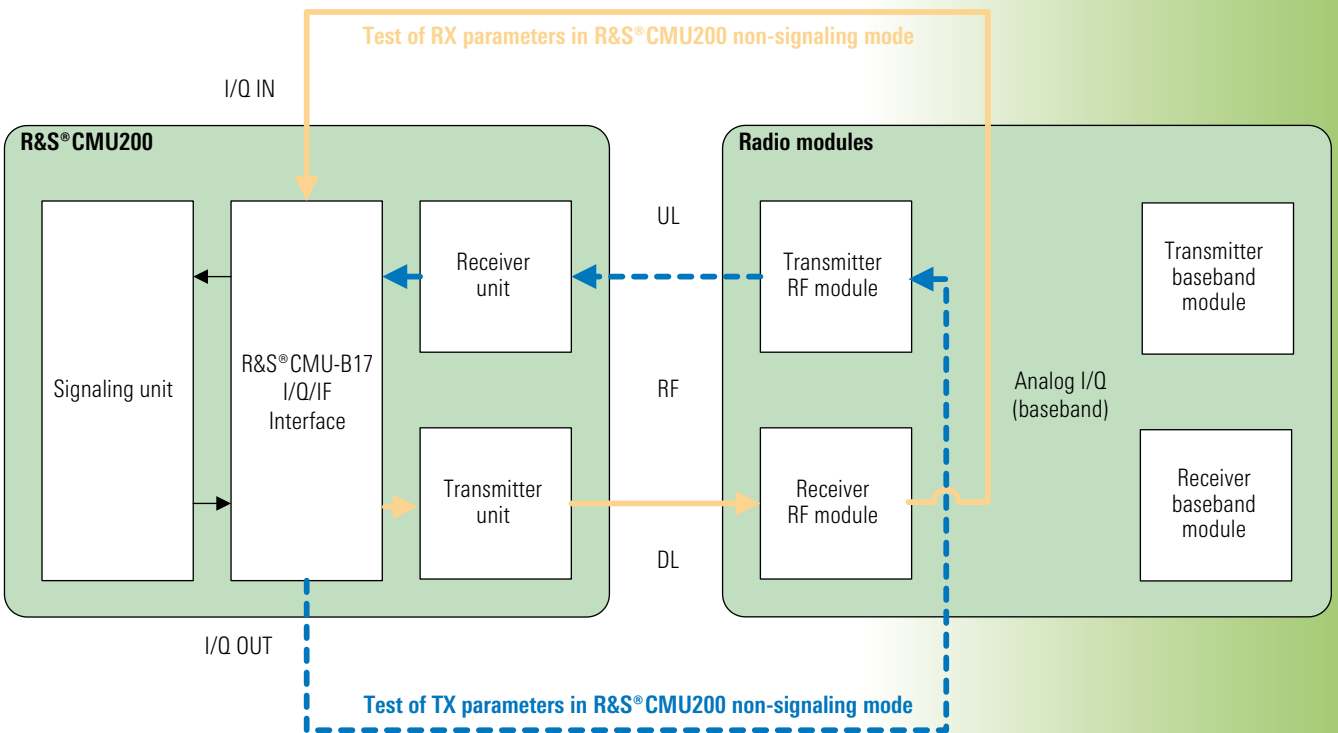
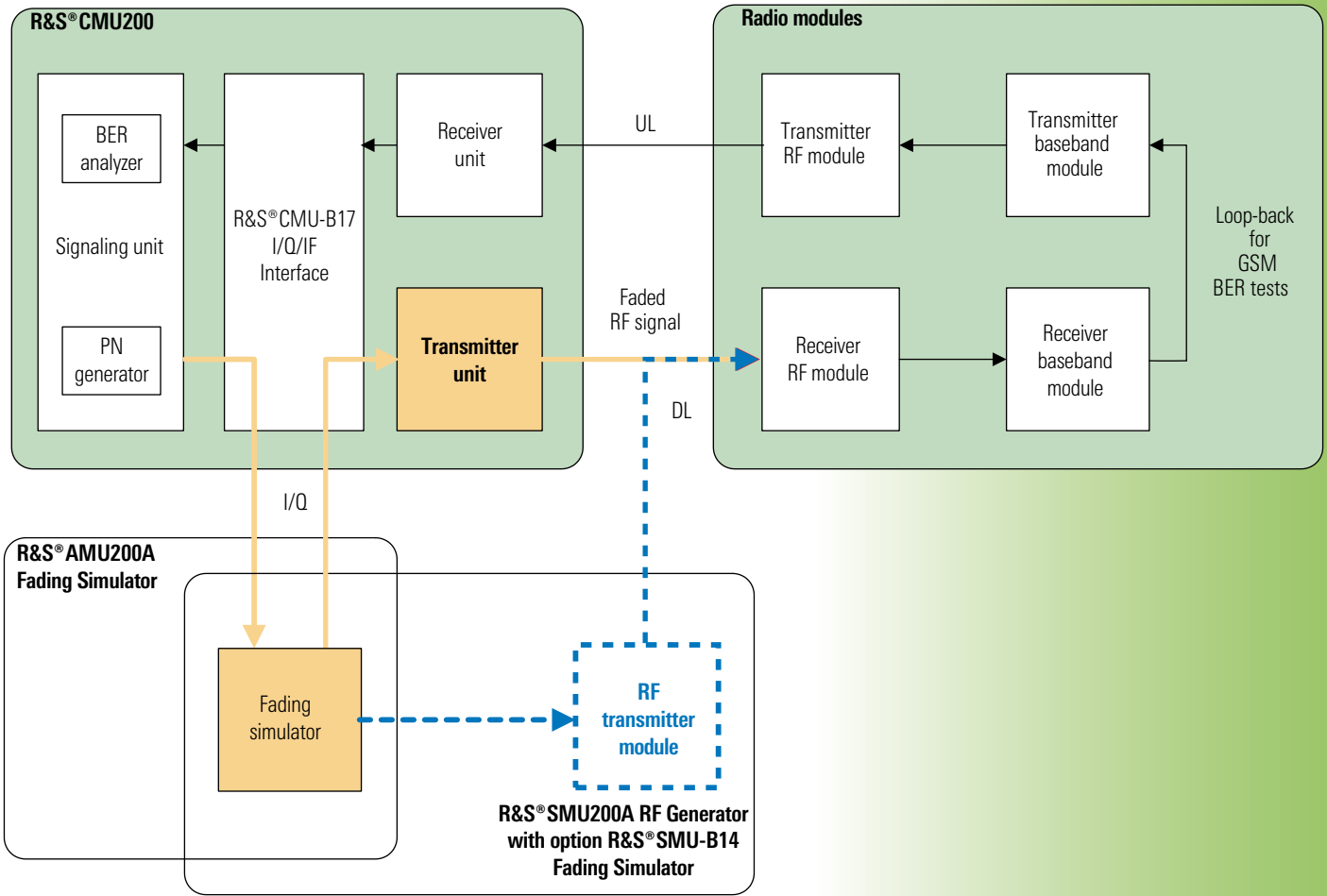

R&S® CMU200 options and accessories

Type	Description	GSM/GPRS/EDGE	TDMA	AMPS	CDMA2000® 1xRTT	CDMA2000® 1xEV-DO	WCDMA/HSPA	Bluetooth®	Order No.
R&S®CMU200	Base unit with following accessories: power cord, operating and service manual for instrument	☑	☑	☑	☑	☑	☑	☑	1100.0008.02
R&S®CMU-B11 ¹⁾	Reference OCXO, aging 2×10^{-7} /year	☺	☺	☺	☺	☺	☺	☺	1100.5000.02
R&S®CMU-B12 ¹⁾	High-stability OCXO, aging 3.5×10^{-8} /year; oven crystal with highest long-term stability	☺	☺	☺	☺	☺	☺	☺	1100.5100.02
R&S®CMU-B17	Analog I/Q IF interface	☺	☺	–	☺	☺	☺	☺	1100.6906.02
R&S®CMU-B21	Universal signaling unit; provides multistandard signaling hardware; required for WCDMA 3GPP FDD	☑	☑	☑	–	–	☑	☑	1100.5200.14
R&S®CMU-B21	Universal signaling unit; includes signaling module for AMPS, TDMA, GSM/GPRS/EGPRS	☑	☑	☑	–	–	☑	☑	1100.5200.54
R&S®CMU-B41	Audio generator and analyzer; includes audio frequency (AF) generator, voltmeter, distortion meter	☺	☺	☑	☺	☺	☺	☺	1100.5300.02
R&S®CMU-B52	Internal versatile multimode speech coder/decoder; R&S®CMU-B21 necessary	☺	☺	–	–	–	☺	☺	1100.5400.14
R&S®CMU-B53	Bluetooth® extension; R&S®CMU-B21 necessary	–	–	–	–	–	–	☺	1100.5700.14
R&S®CMU-B55	HD option for (E)GPRS application testing with more than 2 UL slots	☺	–	–	–	–	–	–	1159.4000.14
R&S®CMU-B56	WCDMA (3GPP FDD) signaling module for R&S®CMU-B21 model 14	☺	–	–	–	–	☑	–	1150.1850.14
R&S®CMU-B68	Versatile baseband board for WCDMA (3GPP FDD) layer 1, DL and UL, non-signaling	–	–	–	–	–	☑	–	1149.9809.02
R&S®CMU-B83 ²⁾	CDMA2000® 1xRTT signaling unit	–	–	–	☑	☑	–	–	1150.0301.12
R&S®CMU-B83 ²⁾	CDMA2000® 1xRTT signaling unit; required for CDMA2000® 1xEV-DO Rev. 0 and A signaling	–	–	–	☑	☑	–	–	1150.0301.22
R&S®CMU-B85	8 k/13 k QCELP, 8k EVRC speech codec for R&S®CMU-B83 CDMA2000® 1xRTT signaling unit	–	–	–	☺	☺	–	–	1100.7002.12
R&S®CMU-B85	8k/13k QCELP, 8k EVRC, EVRC-B speech codec for R&S®CMU-B83 model 22 CDMA2000® 1xRTT signaling unit	–	–	–	☺	☺	–	–	1100.7002.22
R&S®CMU-B87	Interface for extensive CDMA2000® 1xRTT /1xEV-DO data testing for CDMA2000® 1xRTT signaling unit R&S®CMU-B83; requires R&S®CMU-K87	–	–	–	☺	☺	–	–	1150.2404.02
R&S®CMU-B88 ³⁾	CDMA2000® 1xEV-DO Rev. 0 and A non-signaling generator for R&S®CMU-B83 model 12 CDMA2000® 1xRTT signaling unit	–	–	–	☺	☑	–	–	1158.9908.02
R&S®CMU-B89 ³⁾	CDMA2000® 1xEV-DO Rev. 0 and A signaling module for R&S®CMU-B83 model 22 CDMA2000® 1xRTT signaling unit	–	–	–	☺	☑	–	–	1159.3090.02
R&S®CMU-B95	Auxiliary generator that covers the requirements of present BCCH by GSM/GPRS/EGPRS and application testing for (E)GPRS	☺	–	–	–	–	☺	–	1159.0504.02
R&S®CMU-B96	2nd TX RF channel with full functionality; for generation of small-band signal (GSM BCCH, channel A) or of wideband signal (WCDMA BCCH, channel B)	☺	–	–	–	–	☺	–	1159.1600.02
R&S®CMU-B99	RF1 level range identical to RF2	☺	☺	☺	☺	☺	☺	☺	1150.1250.02
R&S®CMU-K14	Stereo FM transmitter	☺	☺	☺	☺	☺	☺	☺	1200.7503.02
R&S®CMU-K16	WCDMA (3GPP FDD) band 10, UE test signaling software (R&S®CMU-B68, R&S®CMU-B21 model 14 or 54, R&S®CMU-B56 necessary)	–	–	–	–	–	☑	–	1200.9158.02
R&S®CMU-K17	WCDMA (3GPP FDD) band 11, UE test signaling software (R&S®CMU-B68, R&S®CMU-B21 model 14 or 54, R&S®CMU-B56 necessary)	–	–	–	–	–	☑	–	1200.9258.02
R&S®CMU-K20	GSM400 mobile station signaling/non-signaling test software	☑	–	–	–	–	–	–	1115.5900.02
R&S®CMU-K21	GSM900, R-GSM, and E-GSM mobile station signaling/non-signaling test software	☑	–	–	–	–	–	–	1115.6007.02
R&S®CMU-K22	GSM1800 (DCS) mobile station signaling/non-signaling test software	☑	–	–	–	–	–	–	1115.6107.02
R&S®CMU-K23	GSM1900 (PCS) mobile station signaling/non-signaling test software	☑	–	–	–	–	–	–	1115.6207.02
R&S®CMU-K24	GSM850 mobile station signaling/non-signaling test software	☑	–	–	–	–	–	–	1115.6307.02
R&S®CMU-K26	GT800 mobile station signaling/non-signaling test software	☑	–	–	–	–	–	–	1115.6507.02
R&S®CMU-K27	IS-136/cellular (800 MHz band) mobile station signaling/non-signaling test software	–	☑	–	–	–	–	–	1115.6607.02

¹⁾ R&S®CMU-B11 or R&S®CMU-B12 possible. One of two OCXOs should be installed to ensure high frequency accuracy, or an external frequency reference may be used, if available.

²⁾ Either R&S®CMU-B83 model 12 or R&S®CMU-B83 model 22 is required.

³⁾ Either R&S®CMU-B88 or R&S®CMUB89 is required.

Type	Description	GSM/GPRS/EDGE	TDMA	AMPS	CDMA2000® 1xRTT	CDMA2000® 1xEV-DO	WCDMA/HSPA	Bluetooth®	Order No.
R&S®CMU-K28	IS-136/PCS (1900 MHz band) mobile station signaling/non-signaling test software	-	✓	-	-	-	-	-	1115.6707.02
R&S®CMU-K29	AMPS mobile station signaling/non-signaling test software	-	-	☑	-	-	-	-	1115.6807.02
R&S®CMU-K42	GPRS test software extension for all GSM test software packages	☺	-	-	-	-	-	-	1115.4691.02
R&S®CMU-K43	EGPRS classic (EDGE) signaling test software for all GSM test software packages	☺	-	-	-	-	-	-	1115.6907.02
R&S®CMU-K44	Dual transfer mode: simultaneous CS and PS connection for all GSM packages	☺	-	-	-	-	-	-	1157.4277.02
R&S®CMU-K45	AMR test software extension for all GSM test software packages	☺	-	-	-	-	-	-	1150.3100.02
R&S®CMU-K46	Wideband adaptive multirate signaling for GSM and WCDMA (GSM or WCDMA signaling option necessary)	☺	-	-	-	-	☺	-	1200.8800.02
R&S®CMU-K47	R&S®Smart Alignment for all GSM and CDMA2000® packages	☺	-	-	☺	☺	-	-	1157.4477.02
R&S®CMU-K48	I/Q versus slot measurement for adjustment of polar modulators	☺	-	-	-	-	-	-	1157.5309.02
R&S®CMU-K53	Bluetooth® test software	-	-	-	-	-	-	☑	1115.5000.02
R&S®CMU-K56	HSUPA 5.7 Mbit/s extension, 3GPP/FDD/UE, Rel.6 (R&S®CMU-B68, R&S®CMU-B21 model 14 or 54, R&S®CMU-B56 necessary)	-	-	-	-	-	☺	-	1200.7803.02
R&S®CMU-K57	WCDMA signaling 3GPP/FDD/UE, band 7 (R&S®CMU-B68, R&S®CMU-B21 model 14 or 54, R&S®CMU-B56 necessary)	-	-	-	-	-	✓	-	1200.7903.02
R&S®CMU-K58	WCDMA signaling 3GPP/FDD/UE, band 8 (R&S®CMU-B68, R&S®CMU-B21 model 14 or 54, R&S®CMU-B56 necessary)	-	-	-	-	-	✓	-	1200.8000.02
R&S®CMU-K59	WCDMA signaling 3GPP/FDD/UE, band 9 (R&S®CMU-B68, R&S®CMU-B21 model 14 or 54, R&S®CMU-B56 necessary)	-	-	-	-	-	✓	-	1200.8100.02
R&S®CMU-K60	HSDPA 14 Mbit/s extension 3GPP/FDD/UE, Rel. 5 (R&S®CMU-K64 necessary)	-	-	-	-	-	☺	-	1200.8200.02
R&S®CMU-K61	WCDMA (3GPP FDD) band 4, UE test signaling software	-	-	-	-	-	✓	-	1157.3670.02
R&S®CMU-K62	WCDMA (3GPP FDD) band 5, UE test signaling software	-	-	-	-	-	✓	-	1157.3770.02
R&S®CMU-K63	WCDMA (3GPP FDD) band 6, UE test signaling software	-	-	-	-	-	✓	-	1157.3870.02
R&S®CMU-K64	3.6 Mbit/s HSDPA	-	-	-	-	-	☺	-	1157.3970.02
R&S®CMU-K65	WCDMA (3GPP FDD) UL user equipment TX test, non-signaling test software	-	-	-	-	-	☑	-	1115.4891.02
R&S®CMU-K66	WCDMA (3GPP FDD) DL generator, non-signaling test software	-	-	-	-	-	☑	-	1115.5100.02
R&S®CMU-K67	WCDMA (3GPP FDD) band 3, UE test signaling software	-	-	-	-	-	✓	-	1150.3000.02
R&S®CMU-K68	WCDMA (3GPP FDD) band 1, UE test signaling software	-	-	-	-	-	✓	-	1115.5300.02
R&S®CMU-K69	WCDMA (3GPP FDD) band 2, UE test signaling software	-	-	-	-	-	✓	-	1115.5400.02
R&S®CMU-K83	CDMA2000® 1xRTT 450 MHz bands (band class 5, 11) test software	-	-	-	✓	-	-	-	1150.3500.02
R&S®CMU-K84	CDMA2000® 1xRTT cellular bands (band class 0, 2, 3, 7, 9, 10, 12) test software	-	-	-	✓	-	-	-	1150.3600.02
R&S®CMU-K85	CDMA2000® 1xRTT PCS bands (band class 1, 4, 8, 14) test software	-	-	-	✓	-	-	-	1150.3700.02
R&S®CMU-K86	CDMA2000® 1xRTT IMT-2000 bands (band class 6, 13, 15, 16, 17) test software	-	-	-	✓	-	-	-	1150.3800.02
R&S®CMU-K87	Extensive CDMA2000® 1xRTT/1xEV-DO data testing; requires R&S®CMU-B87	-	-	-	☺	☺	-	-	1150.4007.02
R&S®CMU-K88	CDMA2000® 1x EV-DO Rev. 0 and A non-signaling test software package for R&S®CMU-B88, including 450 MHz + cellular + PCS + IMT-2000 bands	-	-	-	☺	☺	-	-	1150.3900.02
R&S®CMU-K92	(E)GPRS application testing; external PC, Windows XP/2000, GPRS or EGPRS software option, and R&S®CMU-B95 auxiliary generator plus power PC required	☺	-	-	-	-	-	-	1157.4077.02
R&S®CMU-K96	WCDMA application testing; at least one WCDMA signaling band necessary	-	-	-	-	-	☺	-	1157.4177.02
R&S®CMU-K839	CDMA2000® 1xEV-DO 450 MHz bands (band class 5, 11) test software for R&S®CMU-B89	-	-	-	☺	✓	-	-	1200.8300.02
R&S CMU-K849	CDMA2000® 1xEV-DO Cellular bands (band class 0, 2, 3, 7, 9, 10, 12) test software for R&S®CMU-B89	-	-	-	☺	✓	-	-	1200.8400.02
R&S CMU-K859	CDMA2000® 1xEV-DO PCS bands (band class 1, 4, 8, 14) test software for R&S®CMU-B89	-	-	-	☺	✓	-	-	1200.8500.02
R&S CMU-K869	CDMA2000® 1xEV-DO IMT-2000 bands (band class 6, 13, 15, 16, 17) test software for R&S®CMU-B89	-	-	-	☺	✓	-	-	1200.8600.02

Type	Description	GSM/GPRS/EDGE	TDMA	AMPS	CDMA2000® 1xRTT	CDMA2000® 1xEV-DO	WCDMA/HSPA	Bluetooth®	Order No.
R&S®CMU-PK20 ⁴⁾	Software package for R&S®CMU200 including GSM850 + 900 + 1800 + 1900 + GPRS signaling (R&S®CMU-K21, -K22, -K23, -K24, -K42)	☺	–	–	–	–	–	–	1159.3303.04
R&S®CMU-PK60 ⁴⁾	Software package for R&S®CMU200 including WCDMA signaling: 3GPP/FDD/UE, TX test, DL generator, band 1+2+3+4+5+6 (R&S®CMU-K61, -K62, -K63, -K65, -K66, -K67, -K68, -K69)	–	–	–	–	–	☺	–	1159.3355.04
R&S®CMU-PK80 ⁴⁾	Software package for R&S®CMU200 including CDMA2000® bands 450 MHz + PCS + cellular + IMT-2000; analog AMPS (R&S®CMU-K83, -K84, -K85, -K86, -K29)	–	–	☺	☺	–	–	–	1159.3403.02
R&S®CMU-PK100 ⁴⁾	Software package for R&S®CMU200 including GSM/GPRS/EGPRS + WCDMA + CDMA2000® 1xRTT + 1xEV-DO + AMPS + IS-136 (R&S®CMU-PK20, -PK60, -PK80, -PK800, -K27, -K28, -K43, -K88)	☺	☺	☺	☺	☺	☺	–	1159.3455.06
R&S®CMU-PK800	Software package for R&S®CMU200 including CDMA2000® 1x EV-DO Rev. 0 and A for 450 MHz + cellular+ PCS + IMT-2000 bands (R&S®CMU-K839, -K849, -K859, -K869)	–	–	–	–	☺	–	–	1200.0609.02
R&S®CMU-U80	Low jitter trigger output connector (for A-GPS)	–	–	–	☺	☺	–	–	1150.1750.02
R&S®CMU-Z1	256 Mbyte memory card for use with PCMCIA interface; flash ATA formatted, also named PC Card ATA	☺	☺	☺	☺	☺	☺	☺	1100.7490.04
R&S®CMU-Z6	Enhancement of wideband modulation (WCDMA 3GPP FDD) analyzer accuracy	–	–	–	–	–	☺	–	1150.0001.02
R&S®CMU-Z10	Antenna coupler 900 MHz/1700 MHz to 2200 MHz	☺	☺	☺	☺	☺	☺	☺	1150.0801.10
R&S®CMU-Z11	RF shielded cover, extension for R&S®CMU-Z10	☺	☺	☺	☺	☺	☺	☺	1150.1008.02
R&S®CMU-Z12	Bluetooth® antenna, extension for R&S®CMU-Z10	☺	–	–	☺	☺	☺	☺	1150.1043.02
R&S®CMU-Z13	USB 2.0 feedthrough for R&S®CMU-Z10	☺	☺	☺	☺	☺	☺	☺	1159.1200.20
R&S®CMU-Z46	WCDMA (3GPP FDD) message analyzer and recorder	–	–	–	–	–	☺	–	1159.0804.02
R&S®CMU-Z50	Handset for R&S®CMU200	☺	☺	☺	☺	☺	☺	☺	1159.0104.02
R&S®CMU-Z89	Hybrid mode test kit; for connecting two R&S®CMU200 for CDMA2000® 1xRTT and 1xEV-DO hybrid mode applications	–	–	–	☺	☺	–	–	1200.0750.02
R&S®CMU-DCV	Documentation of calibration values	☺	☺	☺	☺	☺	☺	☺	0240.2193.08
R&S®CRT-Z2	GSM/GPRS test SIM for GSM900 and DCS1800 for loopback mode; required for BER and other applications	☺	–	–	–	–	–	–	1039.9005.02
R&S®CRT-Z12	GSM/GPRS test SIM for GSM850 and PCS1900 for loopback mode; required for BER and other applications	☺	–	–	–	–	–	–	1139.1205.02
R&S®CRT-Z3	3G UICC/USIM test card for UMTS	–	–	–	–	–	☺	–	1139.1005.02
R&S®ZZA-411	19" rack adapter	☺	☺	☺	☺	☺	☺	☺	1069.3283.00

Comments on table

- ☑ mandatory
- ✓ signaling option (at least one is mandatory)
- ☺ optional
- not applicable

⁴⁾ When ordering one of the R&S®CMU-PK20 to -PK100 software packages, the signaling software included in these packages does not have to be ordered separately.

Value-added services

- ◆ Rohde & Schwarz offers a wide range of training programs not only on products but also on new technical developments
- ◆ Rohde & Schwarz application engineers help to optimize the use of the R&S®CMU200 and the overall performance of your local environment
- ◆ Over 70 representative offices and a worldwide network of service and calibration centers ensure Rohde & Schwarz support where you need it

Quality management at Rohde & Schwarz

Lasting customer satisfaction is our primary objective. The quality management system of Rohde & Schwarz meets the requirements of ISO 9001 and encompasses virtually all fields of activity of the company.



For data sheet, see PD 0758.0039.22
and www.rohde-schwarz.com
(search term: CMU200)



ROHDE & SCHWARZ

www.rohde-schwarz.com

Europe: +49 1805 12 4242, customersupport@rohde-schwarz.com
Americas: 1-888-837-8772, customer.support@rsa.rohde-schwarz.com
Asia: +65 65130488, customersupport.asia@rohde-schwarz.com